



Manual

NEP-695

Long-life logging probe

Version: 20221009

Status: Final

Confidentiality: Not confidential

Date: 09 October 2022

Author: Vic Grosjean

Document history

The Observator range is in continuous development and so specifications may be subject to change without prior notice. When in doubt about the accuracy of this document, contact the Observator Group.

NEP-695 Reference documents

Type of document / tool	Product type and name (incl. url)
Datasheet	NEP-695
Manual	NEP-695 CR300
Videos	NEP-695

NEP-5000 Reference documents

Type of document / tool	Product type and name (incl. url)
Software	NEP-5000
CFG files	NEP-5000
Datasheet	NEP-5000
Manual	NEP-5000
Application notes	NEP-5000-SDI-12 option with Campbell logger
	NEP-5000-SDI-12 option for H-522+ & H-500XL loggers
	NEP-5000-SDI-12 option with Hydrospider logger
	NEP-5000-SDI-12, RS485 and analogue: wiper operations
	NEP-5000 multi-point calibration
	NEP-5000 firmware updating procedure
	Pressure calibration
	Shroud installation
	Temperature calibration
	Wiper replacement
Videos	NEP-5000

Revision history

Date	Amendments	Company, position
2019-06-19	Initial document creation	Observator Australia, Document Controller
2019-07-26	Add charging information	Observator Australia, Document Controller
2019-08-19	Completed NEP-695 manual	Observator Australia, Document Controller
2019-08-20	Quality review	Observator Australia, Operation Manager
2019-08-30	Edited packing list	Observator Australia, Document Controller
2020-01-30	Updated document format	Observator Australia, Document Controller
2020-03-09	Updated software installation section	Observator Australia, Document Controller
2022-04-18	Updated product images & change battery section	Observator Australia, Document Controller
2022-07-30	Finalised the change battery section	Observator Australia, Document Controller
2022-09-30	Review and edit download links	Observator Australia, Document Controller
2022-10-09	Update video links	Observator Australia, Document Controller

Procedure sign-off:

Date	Company, position	Status
2019-06-08	Observator Australia, Document Controller	Finished
2019-12-06	Observator Australia, Managing Director	Approved
2020-03-04	Observator Group, Communication Officer	Approved

Distribution list

Date	Company, position

Firmware & manual version

Important Note: Refer to the following manual revisions based on your product serial numbers.

Manual version	Serial number	Firmware version
NEP-695 Manual V2022-09-30	All serial numbers	V1.0

Summary

Thank you for purchasing the new Analite NEP-695 long-life logging probe. It will give you years of service if you install and maintain the probe according to guidelines set out in this manual.

The NEP-695 is an all-in-one device that contains a scriptable Serial Digital Interface SDI-12 logger with an integrated rechargeable battery designed for long-term operations.

The system is housed in a fully water-sealed casing that can support up-to fifty meters of water pressure.

The NEP-695 is designed to fit with the NEP-5000 SDI-12 option, providing an optimised logging solution to monitor the turbidity. The NEP-695 has a built-in 6-pin female SubConn connector as a sensor interface. It provides the ability to connect multiple SDI-12 sensors into the same connector and monitor multiple parameters.

When the NEP-695 is integrated with the NEP-5000 sensor, the following features can be obtained:

- Simple turbidity and temperature reading in auto-range (providing identical functionality as the Analite NEP-495).
- Statistical measurement over a set period of time.
- Event logging through scripting (for instance if the turbidity or temperature is above 20NTU it will start high-speed logging).
- Ability to connect multiple NEP-5000 sensors in multiple levels (data buoys).
- The ability to have a 90-degree NEP-5000 with 180-degree NEP-5000 sensor providing seamless transition between drinking water monitoring to sediment monitoring.
- The option to add secondary SDI-12 parameters such as conductivity, PH and dissolved oxygen via the SDI-12 bus (up to 9 sensors in total).

When using the battery on its own, with the NEP-5000 sensor, the system is capable of measuring 27,000 measurements. This is approximately five months in ten minute-intervals or indefinite use when connected to a 20W solar panel. The main advantage of having a built-in rechargeable battery is that its low running cost. Hence, users are not required to buy expensive batteries.

The NEP-695 is comprised of the Original Equipment Manufacturer (OEM) CR300 built-in logger by Campbell scientific. This is a proven working solution by many Analite customers, which will provide a scriptable logging capability.

Another advantage of using a scriptable logger is to increase the functionality of the existing probe adding event logging, statistical logging, or using additional sensors.

Table of contents

1	Applications	7
2	Safety	8
3	Specification	9
4	What you will find in the box	11
5	Accessories	13
6	Mechanical installation	16
6.1	Connect NEP-695 to a single NEP-5000	16
6.2	NEP-695 Multiple sensor configurations	17
6.3	Mounting NEP-695 into a data buoy	18
6.4	Power NEP-695 using a solar panel for long-term deployment	19
7	Charging & maintenance	20
7.1	Charge NEP-695	20
7.2	Change NEP-695 battery	21
7.3	LED indicators	26
7.4	Maintenance & storage	27
8	Software installation	28
8.1	Download & install PC200W software	28
8.2	Retrieve the collected data	34
8.3	Clear up the memory	38
8.4	Getting started with scripting	39
8.5	Loading the script into NEP-695 logger using the PC200W software	39
9	Appendix A: Default script for single turbidity measurement with optical wiping	41
9.1	Script objectives	41
9.2	Wiring & NEP-5000 configuration	41
9.3	Flow chart	42
9.4	Power estimation	42
9.5	Example code	43
10	Appendix B: Single turbidity measurement and built-in temperature measurement with optical wiping	44
10.1	Script objectives	44
10.2	Wiring & NEP-5000 configuration	44
10.3	Flow chart	45
10.4	Power estimation	45
10.5	Example code	46
11	Appendix C: Multiple turbidity measurements in statistical analysis with optical wiping	47
11.1	Script objectives	47
11.2	Wiring & NEP-5000 configuration	47
11.3	Flow chart	48

11.4	Power estimation	48
11.5	Example code	49
12	Appendix D: How to configure other SDI-12 sensors	50

1 Applications

The NEP-695 products are ideal for water quality, food processing, waste treatment, and environmental compliance for dredging operations. They are also an ideal dropping solution for data-buoys and river monitoring applications. Typical use includes applications such as:

1. Monitoring of streams and rivers
2. Monitoring of water storage bodies, including stratification studies
3. Intermediate and final effluent treatment monitoring
4. Environmental impact studies
5. Hydrological run off studies
6. Ground and bore water analysis
7. Water filtration efficiency
8. Industrial process monitoring
9. Sludge and dredge monitoring



2 Safety



Please check with your supplier or material specifications before using the sensor in an unknown chemical.



Always use the charger provided to power the probe.



Do not intend to use the NEP-695 with logging probes that are not approved by your supplier.



Only use tap water to clean the NEP-695 logging probe.



After end of life, dispose this product according to your local regulations or return it to the manufacturer.

3 Specification

Dimensions	
Length	541.6mm
Diameter	88.9mm

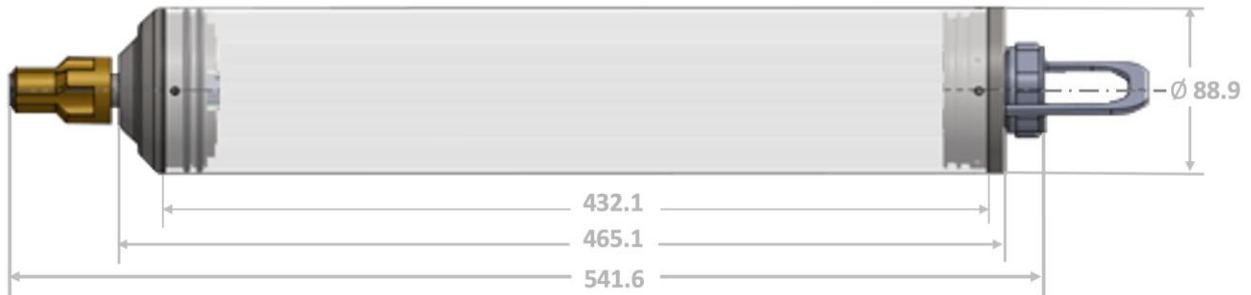

Mechanical	
Weight	2.4kg – including batteries





Specifications	
Operating temperature	-5°C (non-freezing) to 50°C
Storage temperature	-10°C to 55°C
Construction	<p>Outer tube construction with polycarbonate tube with a structural support built using a stainless-steel chassis.</p> <p>The probe interface assembly and rear electrical interface assembly is built using machine Delrin plastic.</p>
Depth rating	52m (170ft) static water column.
Features	<p>Simple turbidity/temperature reading in auto-range.</p> <p>Statistical measurement over a set period of time.</p> <p>Event logging through scripting.</p> <p>Ability to have 90-degree NEP-5000 with 180-degree NEP-5000 sensor providing seamless transition between drinking water monitoring to sediment monitoring.</p> <p>Adding secondary SDI-12 parameters such as conductivity, PH, Dissolved Oxygen via SDI-12 bus (up to 9 sensors in total).</p>

Power	
Batteries	Built-in Lithium-Ion batteries.
Capacity	144Wh
Charger	Direct Current (DC) plug-pack or solar input.
Communication protocol	SDI-12 based scriptable logger.
Measurements	Original Equipment Manufacturer (OEM) CR300 built-in logger by Campbell Scientific.

4 What you will find in the box

When the product is delivered, this is what you will find in the box:



Items found in the box	
<p>NEP-695 logging probe NEP-695 Turbidity & temperature long-life logging probe with loaded script.</p>	
<p>DC charging adapter NEP-695-charge Charger adaptor for NEP-695, including the adaptor for the purchased country.</p>	
<p>Case NEP-695-Case Protective case for NEP-695.</p>	
<p>1m Micro Universal Serial Bus (USB) cable USB-CBL Interface cable to connect the probe to the computer.</p>	

Items found in the box

NEP-5000 Probe

NEP-5000

NEP-CBL - Probe cable in meters.



Blue box calibration module and USB cable*

Module and PC configuration and calibration software.

NEP-CFG

(*) on your first NEP-5000 order only.



SubConn female pigtail**

NEP-CFG-SF

(**) Only included in the shipment when the NEP-5000 has a male SubConn connector. Wiring is different for SDI-12 and RS422/RS485.



Universal Serial Bus (USB) key



Yellow cap



Wiper replacement kit

NEP-WIPER-KIT - comprising of 4 silicon wipers and a hex fastening key.



Direct/External charging adaptor for battery

NEP-695-ADP



O-ring replacement kit for NEP-695

NEP-695-ORI



Battery for NEP-695

NEP-695-BAT



5 Accessories

Observator Instruments offers a wide range of accessories for NEP-5000 & NEP-695. The range of products are directly available from the website:



Accessories	
<p>Case NEP-CASE</p>	
<p>Wiper replacement kit NEP-WIPER-KIT - comprising of 4 silicon wipers and a hex fastening key.</p>	
<p>Shroud NEP-SHRD-D - Delrin protective shroud NEP-SHRD-C - Copper protective shroud NEP-SHRD-S – Stainless steel protective shroud NEP-SHRD-T - Titanium protective shroud</p>	
<p>Spare Micro-USB cable USB-CBL Interface cable to connect the probe to the computer.</p>	

Accessories

Calibration kit for SubConn probes**

NEP-CFG-SF - comprising of a blue box calibration module, USB cable and a SubConn female pigtail.

(**) Only for NEP-5000 with male SubConn connector.

Wiring is different for SDI-12 and RS422/RS485.



Calibration solutions

NEP-CAL-GSF



Brown bottle for calibration

NEP-CAL-BTL



NEP-5000 connection cable

NEP-USB-CON



SubConn connector and cable assembly

NEP-CBL-CON



Direct/External charging adaptor for battery

NEP-695-ADP



O-ring replacement kit for NEP-695
NEP-695-ORI



Spare battery for NEP-695
NEP-695-BAT



Note: Additional customised accessories are also available for long-term deployment or multiple sensor configuration such as: Photovoltaic (PV) panel, long-deployment protective cap.

6 Mechanical installation

6.1 Connect NEP-695 to a single NEP-5000

The following section describes how to connect a single NEP-5000 sensor to the NEP-695 logging probe. Please proceed as follows in order to avoid damaging the NEP-695 connector:

- Firmly hold the NEP-5000 probe. Adjust the NEP-5000 male connector to fit the female NEP-695 connector.



- Turn the NEP-695 moving part clockwise to attach the logging probe to the NEP-5000 sensor. Always loosely hold the NEP-695 moving part while firmly holding the NEP-5000 sensor (in order to avoid damaging the NEP-695 connector).

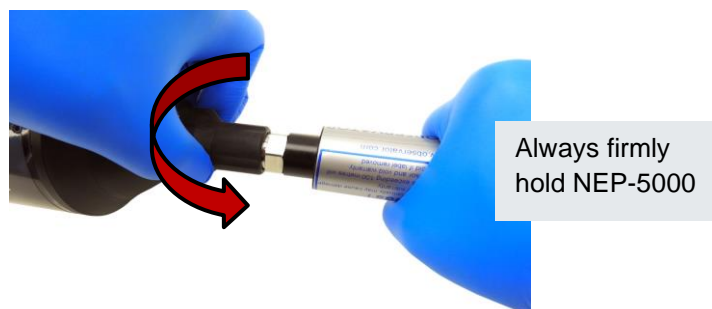

The following block diagram represents the connection of the NEP-695 connected to a single sensor:

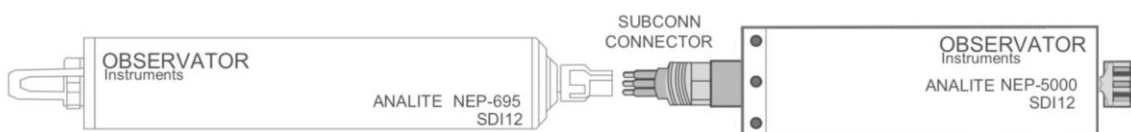

Figure 6.A: Connect NEP-695 to a single NEP-5000

6.2 NEP-695 Multiple sensor configurations

Users may apply the following configuration diagram to power multiple NEP-5000 sensors (up to 9 sensors in parallel):

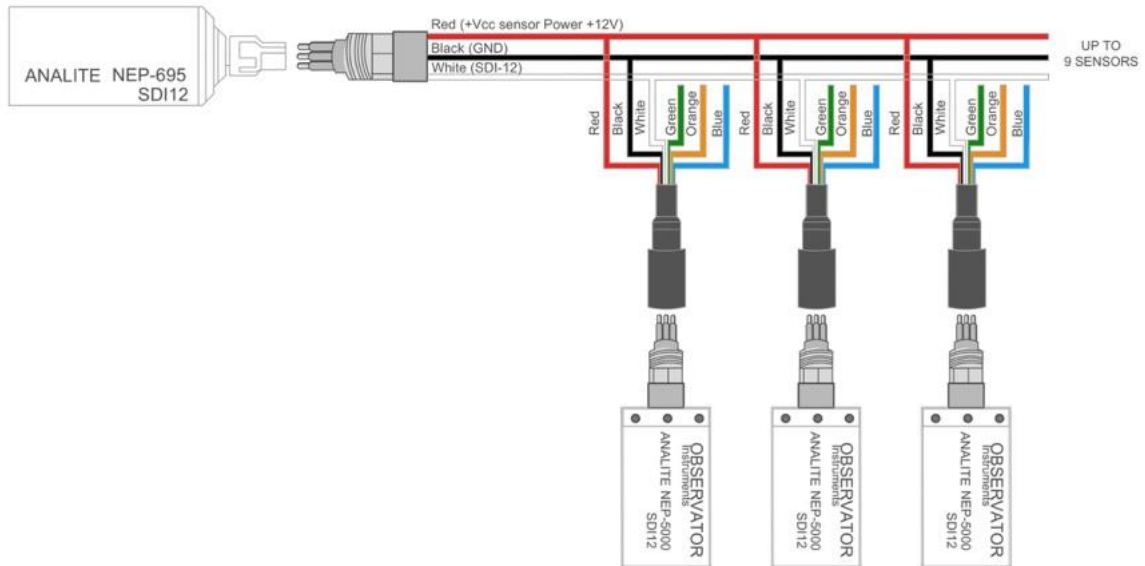

Figure 6.B: Connect NEP-695 to multiple NEP-5000

Note: Please contact your sensor manufacturer to request our special made cables for multiple sensor configuration.

6.3 Mounting NEP-695 into a data buoy

The NEP-695 is designed for long term monitoring applications such as data buoy deployments.



Important note: Never apply pressure to the body of the sensor. Always attach the NEP-695 using the attachment point on the top part. Do not use cable clamps. Do not crush the body of the sensor.



Note: A range of data-buoys fitting NEP-695 logging applications are available from the manufacturer. Please contact Observator Instruments for more information.



6.4 Power NEP-695 using a solar panel for long-term deployment

Users may apply the following power diagram to power the NEP-695 using a PV panel for long-term usage or remote deployment:

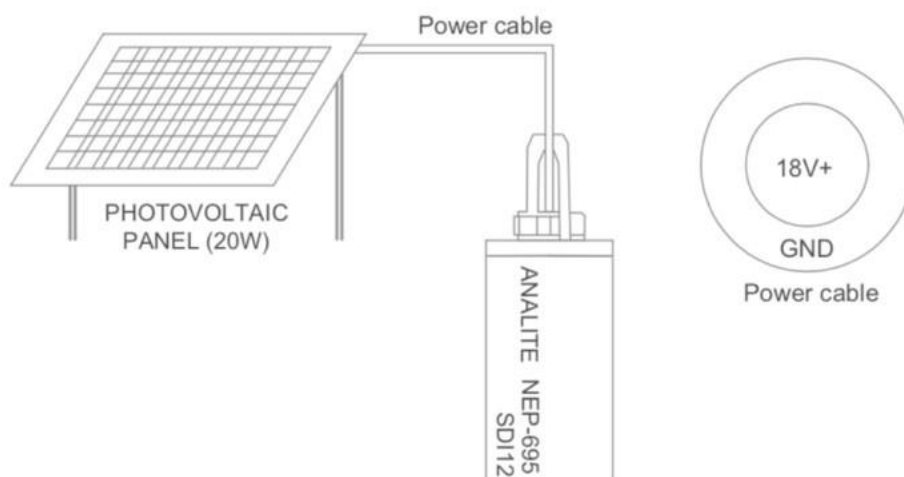

Figure 6.C: Power NEP-695 using a solar panel

Note: Additional customised accessories are available from Observator Instruments for long-term usage such as PV panels and long-deployment protective caps.

7 Charging & maintenance

7.1 Charge NEP-695

Follow these instructions to charge the NEP-695 logging probe:

1. To avoid any risk of water ingress falling onto the electronics, flip the probe up-side down, hold the main body of the probe tight and unscrew the control lid off (make sure to let the water evacuate and dry the lid completely). Undo the protecting cap from the logging probe by turning anti-clockwise until turning has no-longer any effect. Then, firmly disengage the cap from the internal protective O-ring (hear the click).

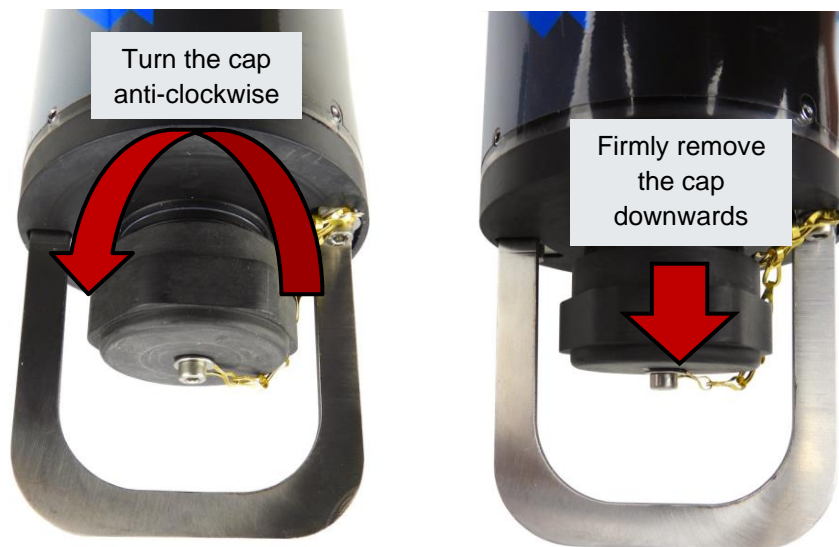

2. Charge the NEP-695 logging probe by placing the provided charging adapter into the centre pin and apply power to the logging probe.



3. It will take on average eight hours to fully charge the logging probe from flat battery.

4. Remove the charging cable and place the protective cap back onto the probe. Firmly press down to engage the O-ring (and ensure the sealing). Once engaged, screw the cap by slowly turning clockwise until the cap is fully screwed on.

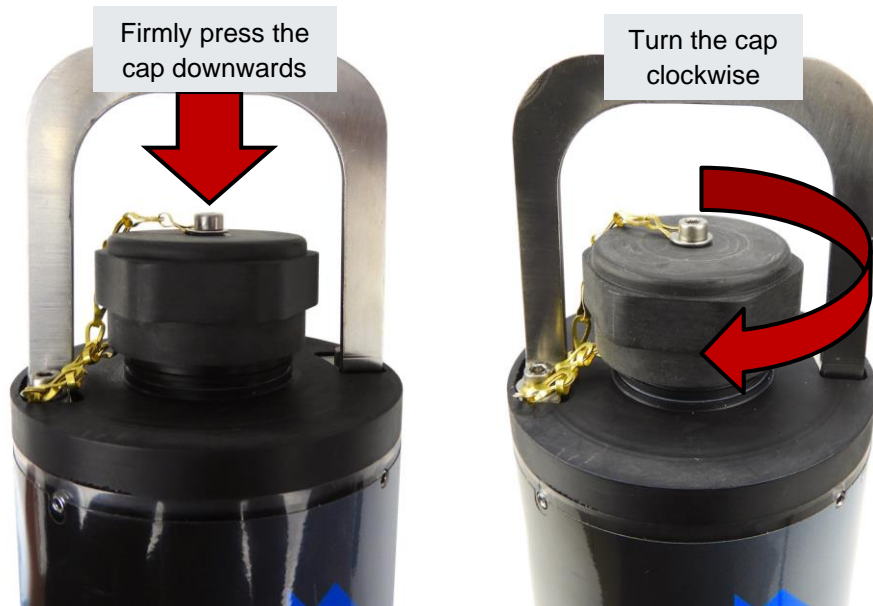

Note: Do not over-tighten the cap as the sealing is ensured by the engagement O-ring (not the level of tightness). By tightening too much the cap will damage the thread and may result in leaking.

7.2 Change NEP-695 battery

It is both very similar to change the battery on NEP-695 and NEP-595:

- Check the NEP-695 power switch status: Check the Light-Emitting Diode (LED) status. If the LED is flashing (usually once every 10 seconds), you will need to manually switch off the switch.
- To avoid any risk of water ingress falling onto the electronics, flip the probe up-side down, hold the main body of the probe tight and unscrew the control lid off (make sure to let the water evacuate and dry the lid completely).

- Flip the probe straight, and manually switch off the probe (the LED will no-longer be flashing).

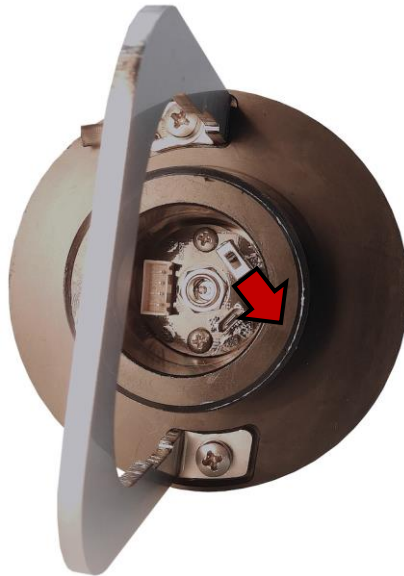

- Partially place the control lid back on (you only need to screw a few threads for the lid to hold in place).
- Hold the main body of the probe tight and unscrew the battery lid off (be gentle and do not pull too much on the battery cables).



- Flip the probe up-side down, and partially lift the orange tape just enough to see where the battery is connected.



- Press on the battery connector pin (use a tool or nails as necessary) while pulling the connector off at the same time.



- Lift the battery all the way and remove the battery.



- To install the new battery, make sure the male connector faces the connector head before placing the battery into the probe (the battery should be placed exactly with the same orientation as before and it should fully align with the cable).



- Partially hold the battery using the orange tape just enough to connect the battery connector. You should be hearing a 'click' sound which means it is connected.



- Lower down the battery and tidy up the 2 cables (gently press the cables in each corner, the cables should lie flat with the other cables).



- Screw the battery lid on until it is tight. Always visually make sure there is no gap left.



- Flip the probe straight, unscrew the control lid and manually switch on the probe.

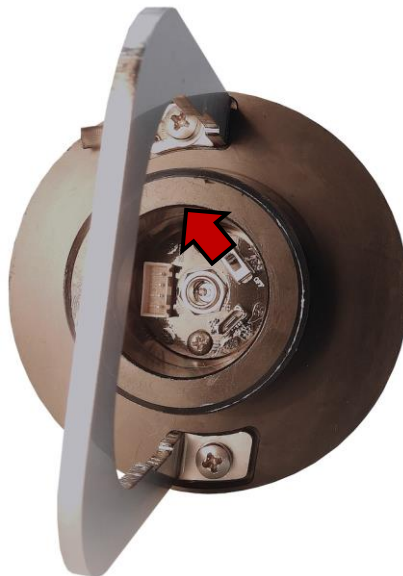

- Screw the control lid onto the probe until it is tight. Always visually make sure there is no gap left.
- Check the LED status, if the red LED is flashing on every 10 seconds, it means that the probe is logging.

7.3 LED indicators

When the data logger is powered, the “red” power LED will turn on according to the power and program states:

- Off: No power, no program is running.
- 1 flash every 10 seconds: Powered from battery, program is running.
- 3 flashes every 10 seconds: Powered via USB, program is running.
- Always on: Powered, no program is running.

If you switch on the NEP-595 switch, both green and red LED will turn on.



7.4 Maintenance & storage

It is strongly recommended that the logging probe be thoroughly washed in clean water after deployment and prior to storage. In the field, wash the probe with fresh water and clean it with a soft cloth. In the office, we recommend to clean the sensor with fresh water and dry the sensor with compressed air.

Important note: Always switch off the NEP-695 after use. Use the power switch underneath the cap to switch off the logging probe (even if not connected to the NEP-5000 sensor) to avoid the script running continuously.

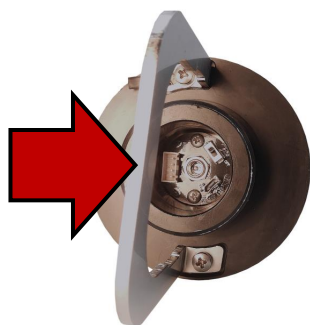

8 Software installation

8.1 Download & install PC200W software

1. Register an account onto "[Campbell Scientific website](#)".
2. Go to the "[PC200W download page](#)" and download the software.
3. To avoid any risk of water ingress falling onto the electronics, flip the probe up-side down, hold the main body of the probe tight and unscrew the control lid off (make sure to let the water evacuate and dry the lid completely). Undo the protecting cap from the logging probe by turning anti-clockwise until turning has no-longer any effect. Then, firmly disengage the cap from the internal protective O-ring (hear the click).

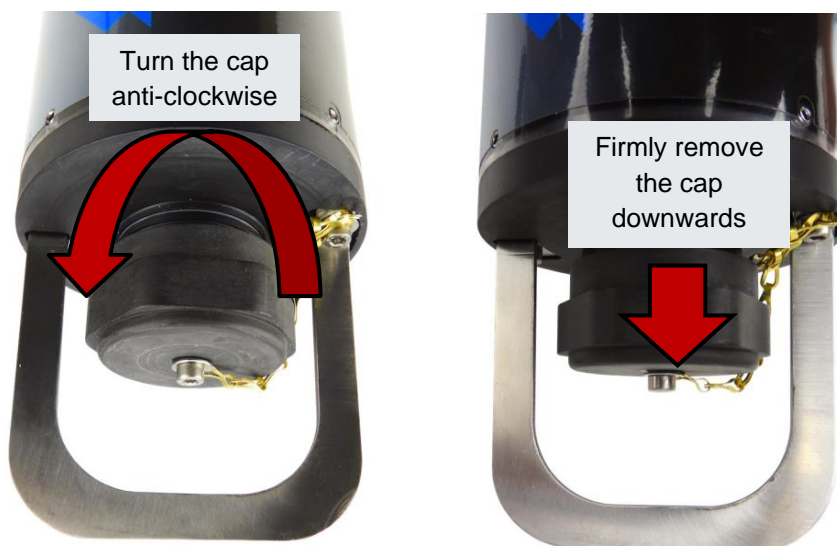

4. Connect your computer to the NEP-695 probe using the Micro-USB cable provided.

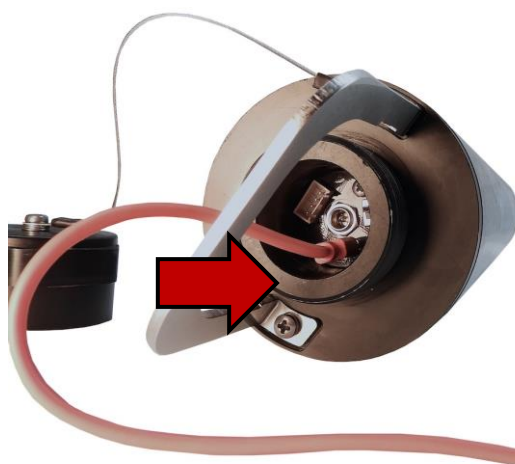

5. Run the software on to your Windows machine and select “Next”.

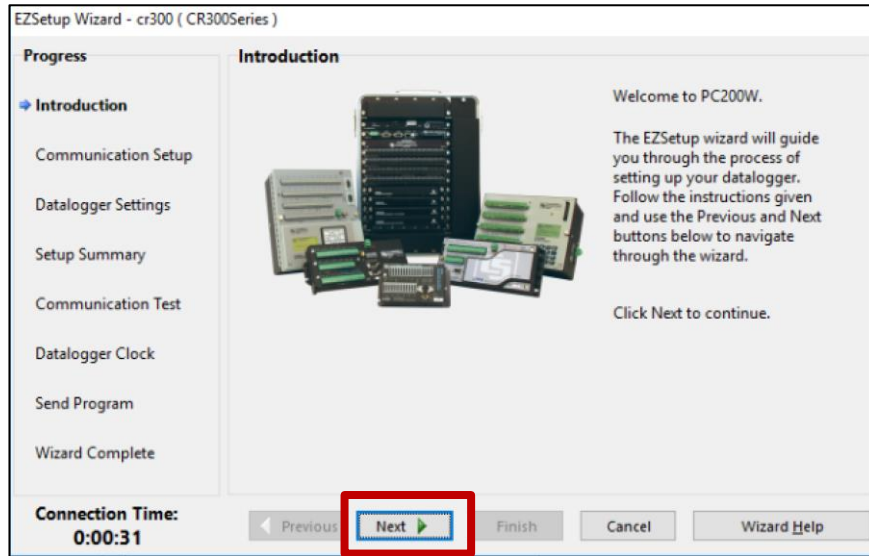

6. Select “CR300Series” data logger and select “Next”.

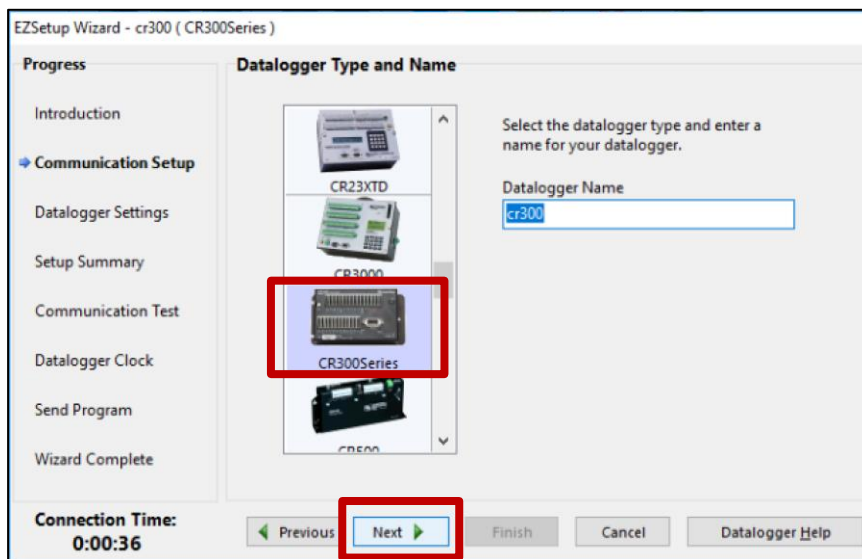

7. Open the “Windows device manager” from your control panel, find the newly connected device and identify the Communication port (COM port) number.

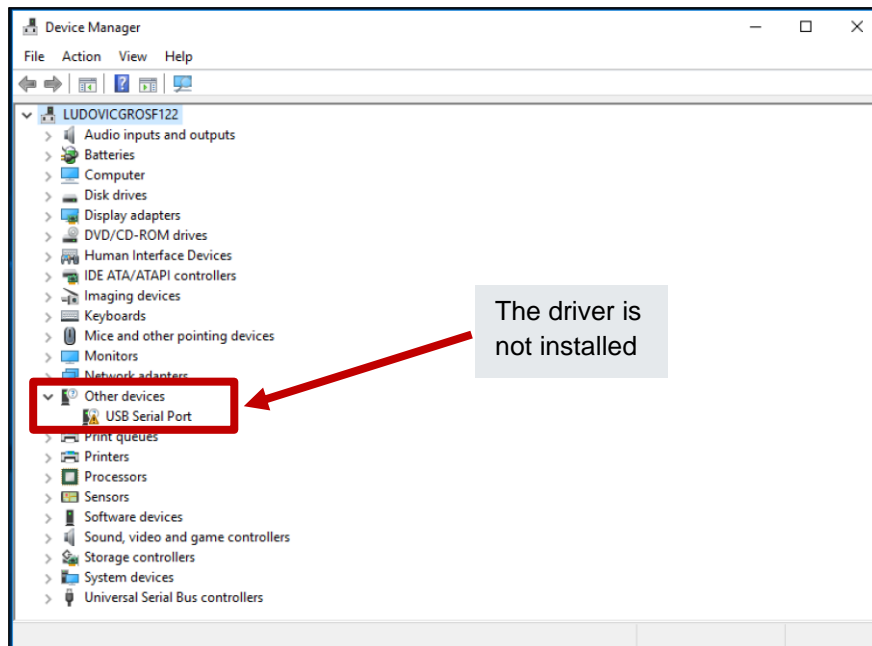
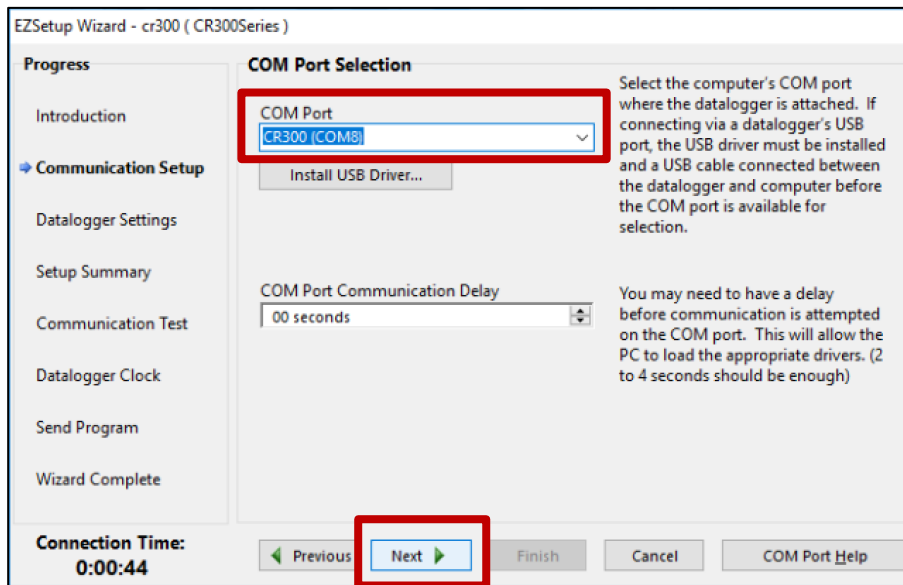

Figure 8.A: Device manager window

Select "CR300" COM port and select "Next".



Note: User may be required to select "Install USB Driver" prior to selecting the correct port.

8. Select “115200” baud rate and select “Next”.

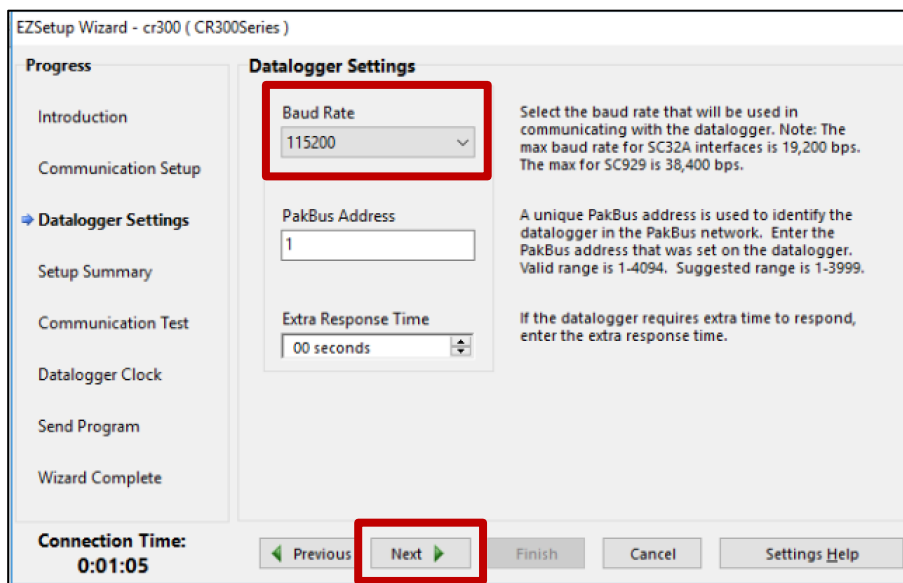

9. Select “0” security code and select “Next”.

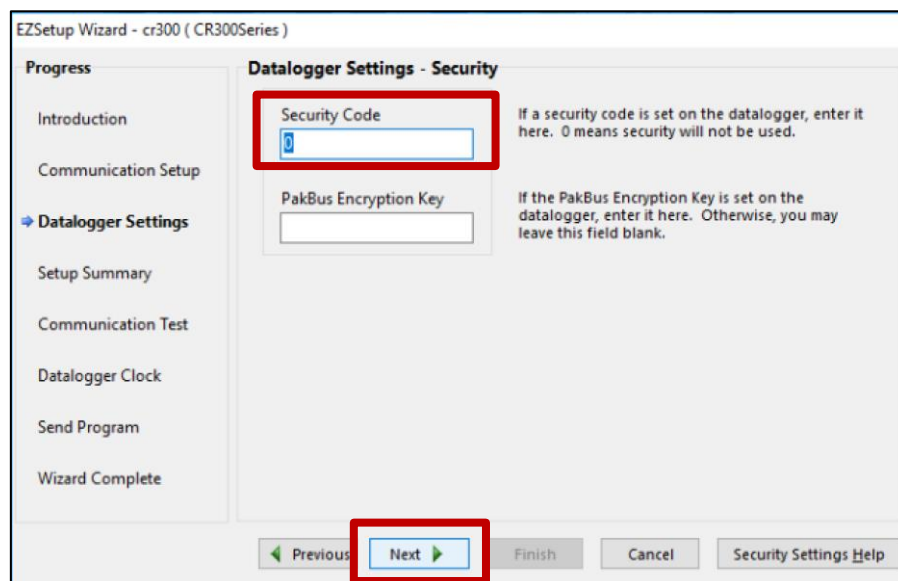

10. Select “Next”.

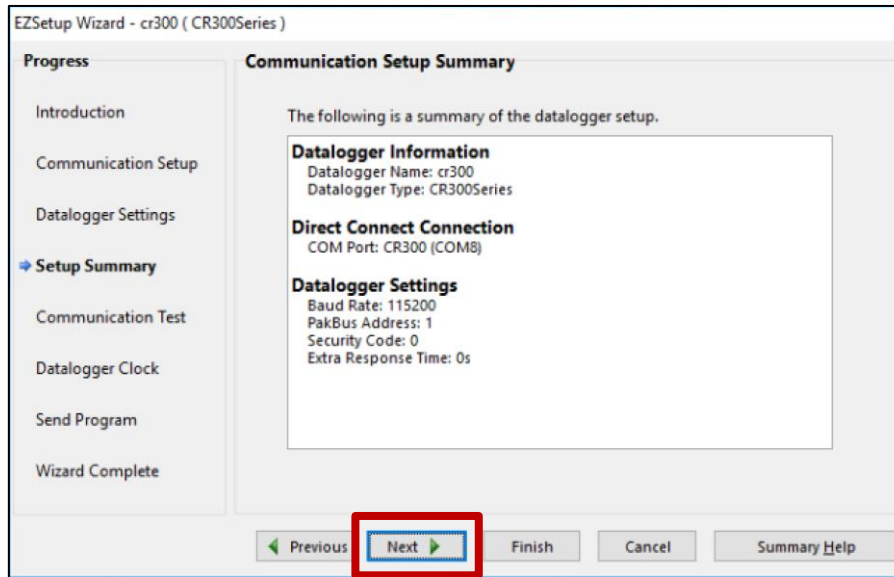

11. Select “Yes” to test the communication and select “Next” a few times.

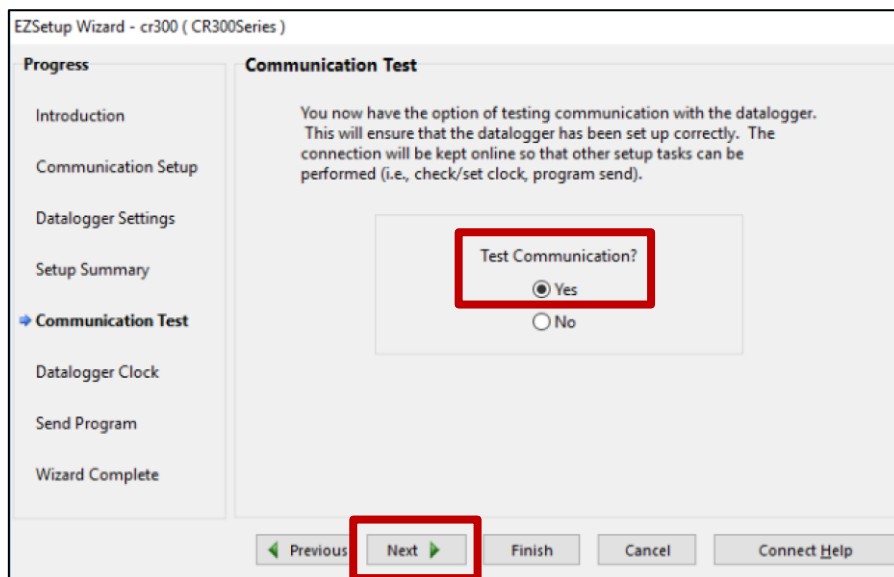

12. Setup the clock and select “Next” a few times or “Finish”.

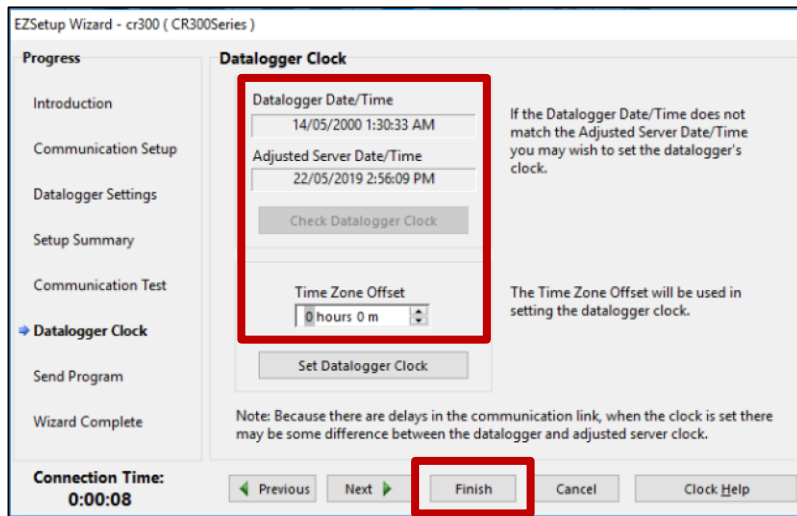

13. When finished, select disconnect on the Personal Computer (PC) configuration software.

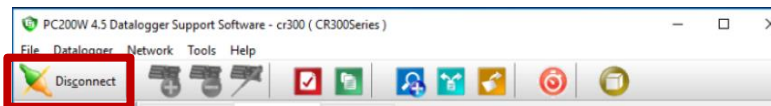

14. Disconnect the Micro-USB cable from your computer and from the NEP-695 probe and place the protective cap back onto the probe. Firmly press down to engage the O-ring (and ensure the sealing). Once engaged, screw the cap by slowly turning clockwise until the cap is fully screwed on.

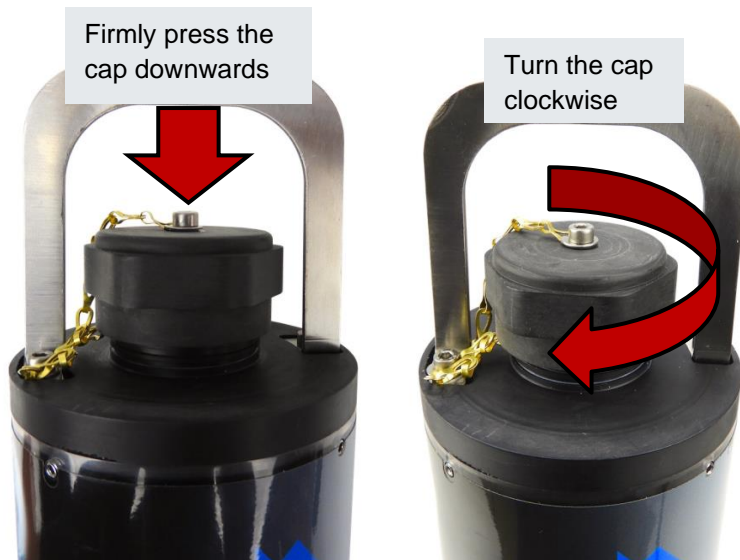

Note: Do not over-tighten the cap as the sealing is ensured by the engagement O-ring (not the level of tightness). Tightening too much the cap will damage the thread and may result in leaking.

8.2 Retrieve the collected data

1. Connect the NEP-695 to your computer (refer to **section 8.1** “Download & install PC200W software”, **steps 3 & 4**).
2. Open PC200W software and select connect.

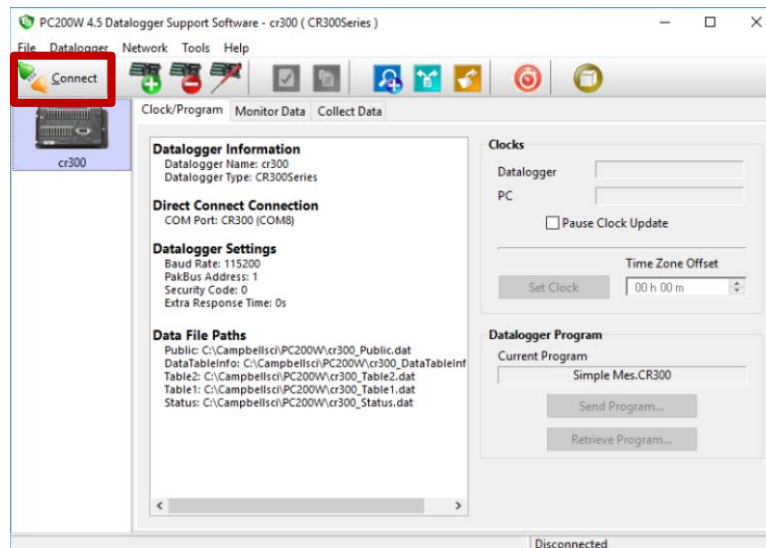

3. Select the “Monitor Data” tab to observe the temperature and turbidity value in real time.

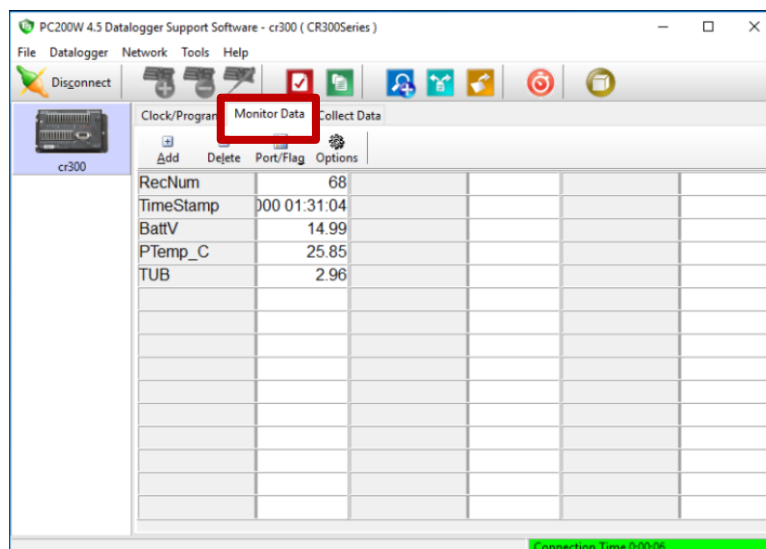

Note 1: User can “Add” and “Delete” cells as required in this menu.

Note 2: The data observed comes from the default logger settings.

4. To start downloading data, select the “Collect data” tab.

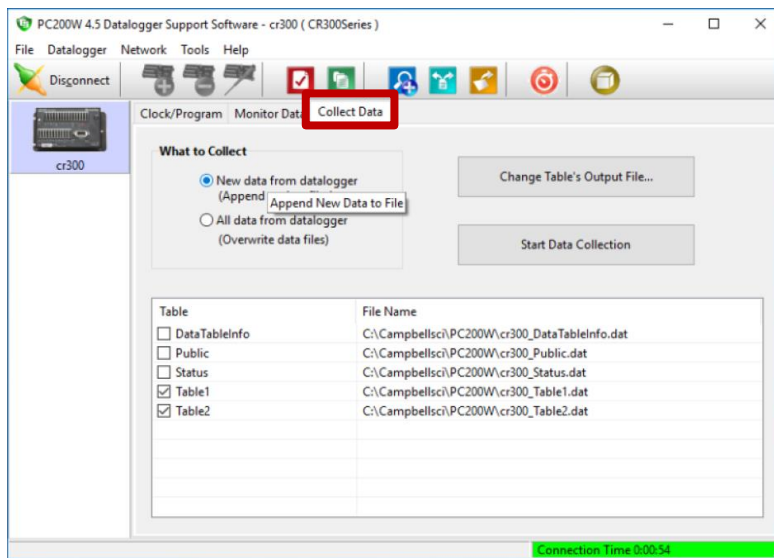

5. Select “New data from data logger”, then double click on the table.

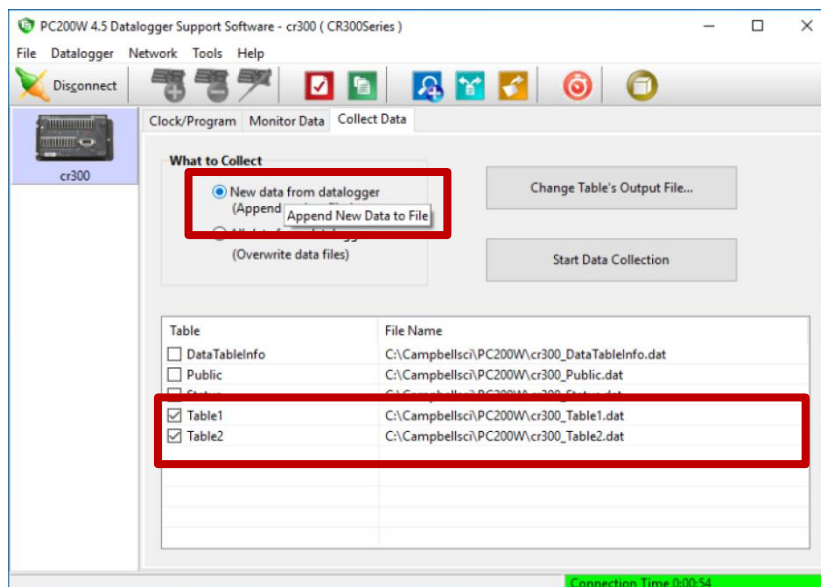

6. Select the table you wish to extract and select “OK”.

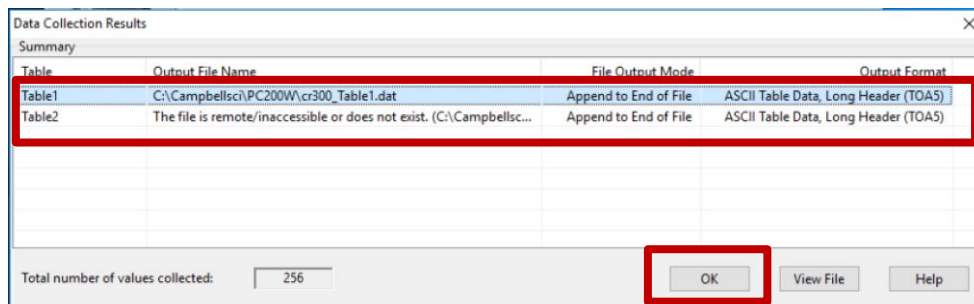

7. Select the file output format type (e.g. *.csv), select the location, and click “Save”.

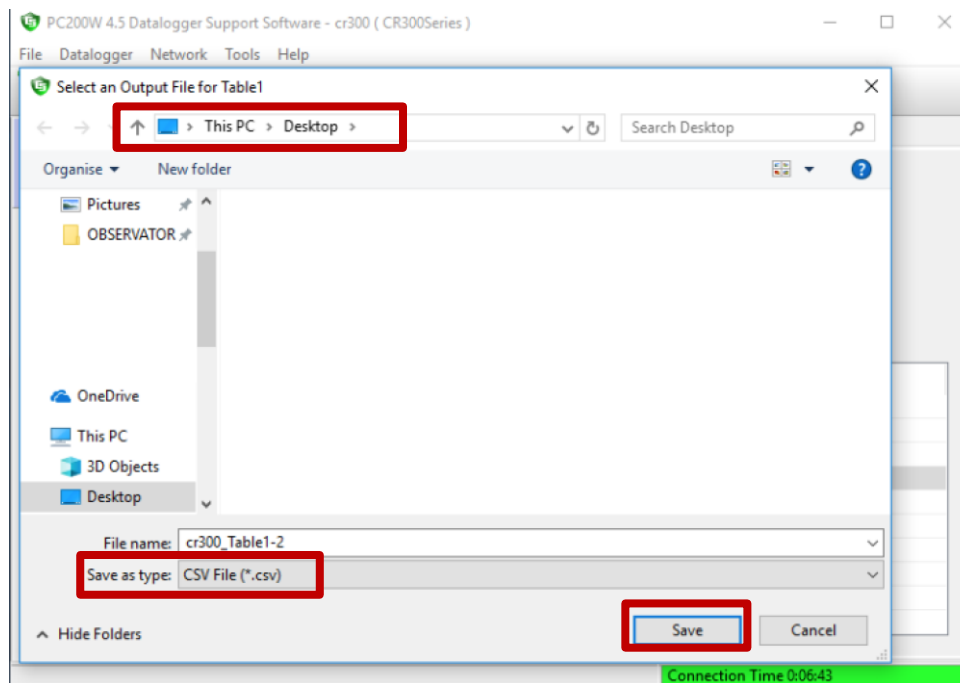

Note: By default, the file format is set to “.dat”.

8. Finally click on “Start data collection” (to actually save the file), and select “OK”.

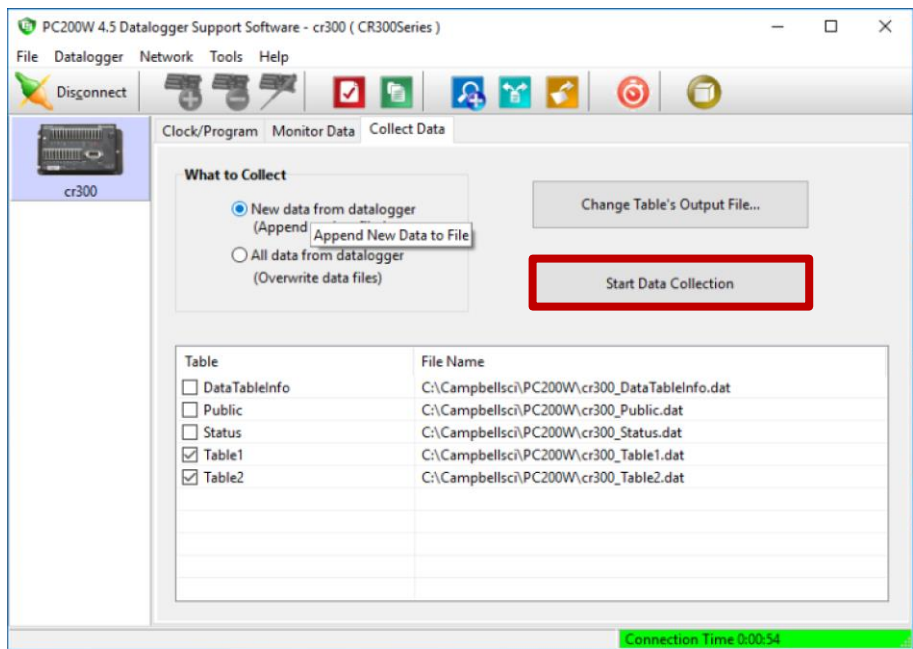

9. When finished, select “Disconnect” on the PC configuration software.

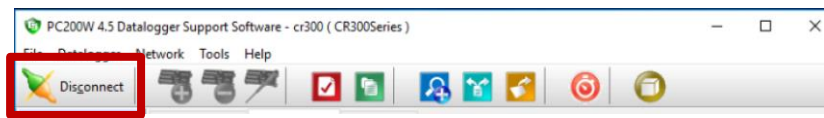

8.3 Clear up the memory

Before a new deployment, users may wish to clear the memory on the NEP-695 probe as follows:

1. In the menu, select “Data logger” and “File Control...”.

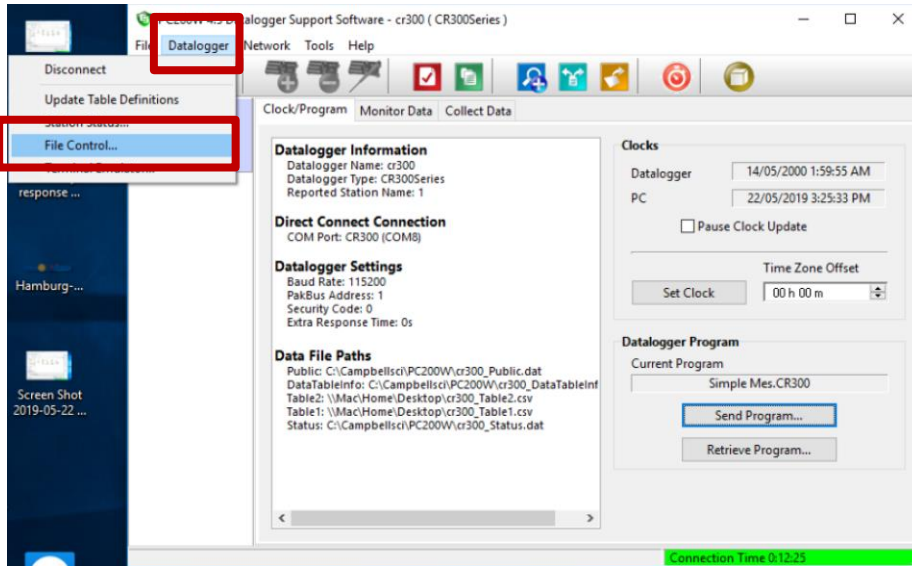

2. Select the file you wish to be removed and click “Delete”.

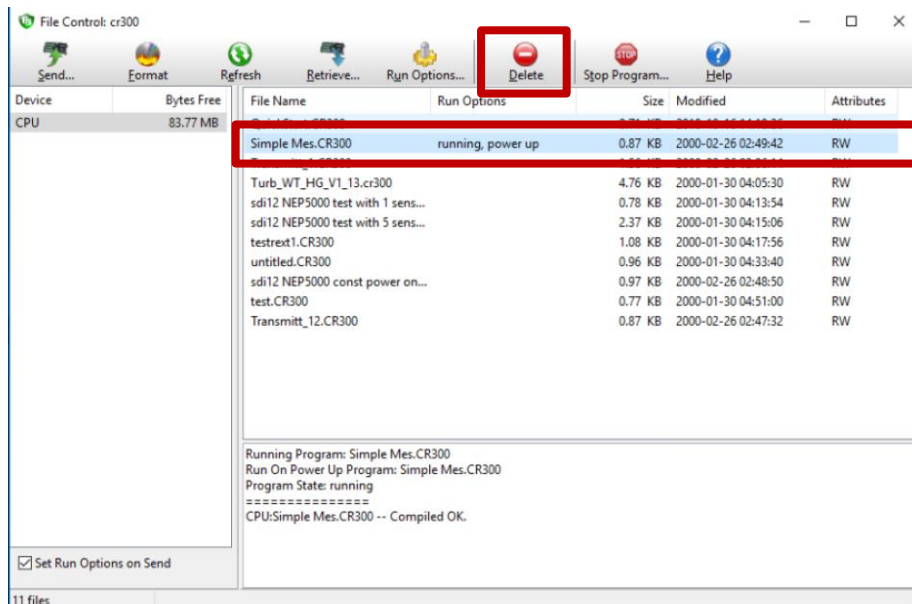

Note: User may also select the “Format” option to clear all files from the system.

8.4 Getting started with scripting

The NEP-695 comes with a pre-loaded built-in script (default script) which can be used to operate with NEP-5000 sensors. Please refer to **section 9**, “[Appendix A: Default script for single turbidity measurement with optical wiping](#)” to access the default script for single turbidity measurement with optical wiping section for more information.

If needed, users can change the default script to a custom script using the software wizard. Please refer to **section 8.5**: “[Loading the script into NEP-695 logger using the PC200W software](#)” for more information.

8.5 Loading the script into NEP-695 logger using the PC200W software

Loading a custom script into the logging probe memory can easily be done using the software wizard. Users must pay attention to key conditions prior to proceeding with the CR-300 software.

1. Connect the NEP-695 to your computer (Refer to **section 8.1**. “[Download & install PC200W software](#)”, **step 3 & 4**).
2. In the CR-3000 software, click on “Send Program...”.

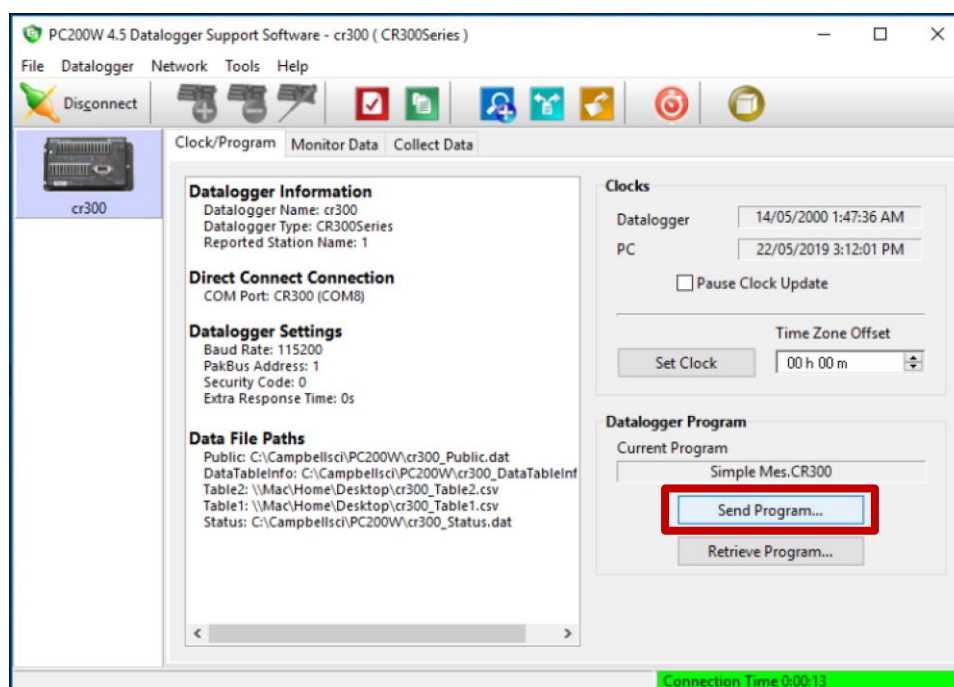

3. Select “Yes”, then, select your script file.

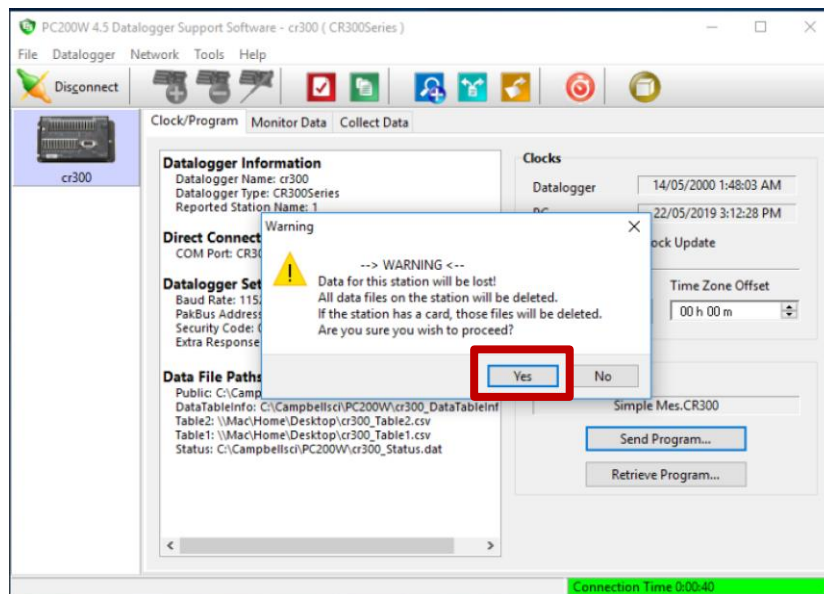

Note: Examples of script files are available in the appendixes of this manual.

9 Appendix A: Default script for single turbidity measurement with optical wiping

9.1 Script objectives

The default script is pre-loaded onto all NEP-695 logging probes (unless otherwise requested). The script turns on the sensor. After the warm up time elapses, it performs an optical wiping followed by a single turbidity measurement and stores data at each scan (every minutes). Then the script calls two data tables and stores the data within the datalogger:

- The script records the wiping status (if jammed or not) of the probe (Wipe_stats) and the turbidity (Turbidity) in NTU within a data table (Table1) at each scan (every 5 minutes).
- The script records the minimum default CR300 Battery Voltage (BattV) and the processor temperature measurement (PTemp_C) within another data table (Table2) once a day.

The script uses the SDI-12 command “M1!” to trigger a wipe and the command “M!” to perform a turbidity measurement.

9.2 Wiring & NEP-5000 configuration

Please refer to **section 6.1** “Connect NEP-695 to a single NEP-5000” to properly setup and connect the logging probe to the NEP-5000 sensor.

Connect the NEP-5000 probe to your Windows computer using the “Blue Box”. Configure the NEP-5000 ranges using the NEP-5000 software. Apply SDI-12 settings.

Please refer to the NEP-5000 manual for more information.

The image displays two alternative software configurations for the NEP-5000 sensor. The left configuration is for 'Auto-Range', where the 'Auto' radio button is selected under 'SET Operating Range'. Below this, a table defines range transition settings: 0 to 97 NTU for Low range, 103 to 995 NTU for Medium range, and 1005 to 3000 NTU for High range. The right configuration is for 'Single Range', where 'High NTU' is selected. It shows a 2-point calibration with 'Bottom NTU (Input RAW)' at 156, 'TopEnd NTU (Input RAW)' at 3540, and 'TopEnd NTU Value' at 3000. Both configurations show the 'Output Control' section with 'SDI12' checked and 'accusation time' set to 5 seconds. The 'accusation time' field is circled in red in both screenshots.

To commit above settings to permanent memory please press set followed by save calibration

Must include:

- SDI-12 data accusation time = 10s
- SDI-12 address = 0
- Power on wipe off

9.3 Flow chart

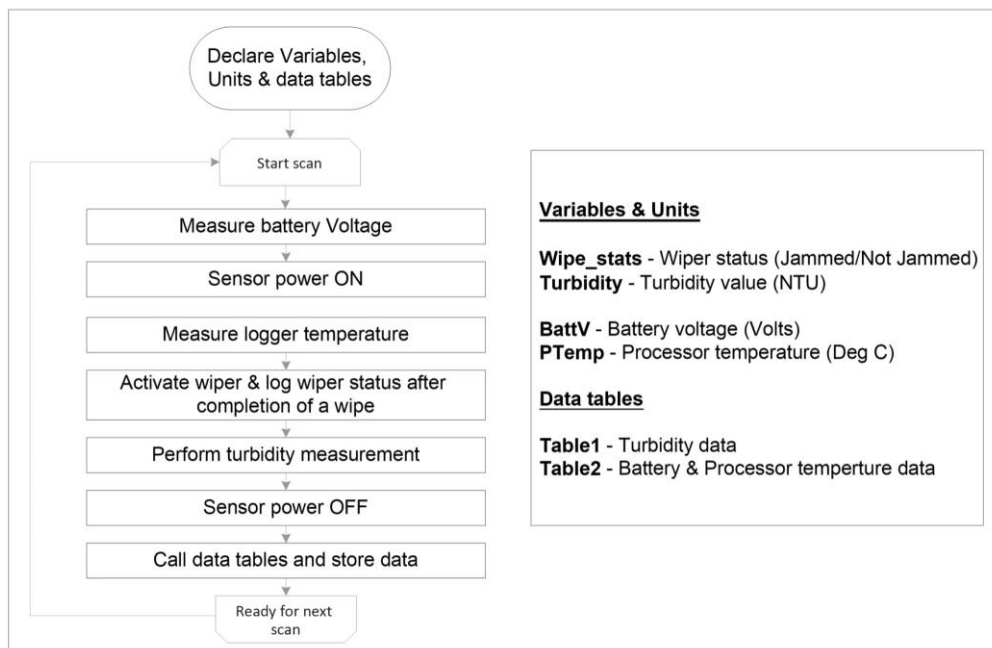

9.4 Power estimation

The following table represents the power estimation for turbidity in auto-range (ten seconds) with optical wipe.

Logging time (min)	Measurement days	Measurement months	Average current (mAh)	Total sleep time per hour (sec)
1	28	0.9	14.7	2340
5	105	3.5	3.9	3348
10	163	5.4	2.55	3474
20	222	7.4	1.87	3537
30	252	8.4	1.65	3558
40	271	9.0	1.53	3568
50	283	9.4	1.47	3574
60	292	9.7	1.42	3578

Note: All of the above estimations are calculated for ideal temperatures of 25°C. Battery aging and self-discharge are not considered. When deploying for more than three months, the estimation can vary by approximately 30%.

9.5 Example code

The following script can be adapted to perform similar operations (e.g. change scanning intervals, add data storing tables, change units, etc...).

```
'CR300 Series

'Declare Variables and Units
Public BattV
Public PTemp_C
Public SDI12_1(1)
Public SDI12_2(1)

Alias SDI12_1(1)=Wipe_stats
Alias SDI12_2(1)=Turbidity

Units BattV=Volts
Units PTemp_C=Deg C
Units Wipe_stats=Unit
Units Turbidity=NTU

'Define Data Tables
DataTable(Table1,True,-1)
  DataInterval(0,5,Min,10)
  Sample(1,Wipe_stats,FP2)
  Sample(1,Turbidity,FP2)
EndTable

DataTable(Table2,True,-1)
  DataInterval(0,1440,Min,10)
  Minimum(1,BattV,FP2,False,False)
  Sample(1,BattV,FP2)
  Sample(1,PTemp_C,FP2)
EndTable

'Main Program
BeginProg
  'Main Scan
  Scan(5,Min,1,0)
  SW12(1)
  Delay(0,5,SEC)
  'Default CR300 Datalogger Battery Voltage measurement 'BattV'
  Battery(BattV)
  'Default CR300 Datalogger Processor Temperature measurement 'PTemp_C'
  PanelTemp(PTemp_C,60)
  'Generic SDI-12 Sensor measurements 'Wipe_stats'
  SDI12Recorder(SDI12_1(),C1,"0","M1!",1,0)
  'Generic SDI-12 Sensor measurements 'Turbidity'
  SDI12Recorder(SDI12_2(),C1,"0","M!",1,0,-1)

  'Call Data Tables and Store Data
  CallTable Table1
  CallTable Table2
  SW12(0)
  NextScan
EndProg
```

10 Appendix B: Single turbidity measurement and built-in temperature measurement with optical wiping

10.1 Script objectives

This script can be loaded onto all NEP-695 logging probes using the CR-300 PW200 application. The script turns on the sensor. After the warm up time elapses, it performs an optical wiping followed by a single turbidity measurement, a temperature measurement and stores data at each scan (every 5 minutes). Then the script calls two data tables and stores the data within the datalogger:

- The script records the wiping status (if jammed or not) of the probe (Wipe_stats) and the turbidity (Turbidity) in NTU and the liquid temperature (Liquid_Temp) within a data table (Table1) at each scan (every five minutes).
- The script records the minimum default CR300 Battery Voltage (BattV) and the processor temperature measurement (PTemp_C) within another data table (Table 2) once a day.

The script uses the SDI-12 command “M1!” to trigger a wipe, the command “M!” to perform a turbidity measurement and “D1!” to perform a temperature measurement.

10.2 Wiring & NEP-5000 configuration

Please refer to **section 6.1** “Connect NEP-695 to a single NEP-5000” to properly setup and connect the logging probe to the NEP-5000 sensor.

Connect the NEP-5000 probe to your Windows computer using the “Blue Box”. Configure the NEP-5000 ranges using the NEP-5000 software. Apply SDI-12 settings.

Please refer to the NEP-5000 manual for more information.

The image displays two alternative configurations for the NEP-5000 software. Both configurations are shown in the 'Range Calibration' window. The left configuration is labeled 'Auto-Range' and features a table with three NTU ranges: 0-97 (Low), 103-995 (Medium), and 1005-3000 (High). The right configuration is labeled 'Single Range' and has 'Low NTU', 'High NTU', and 'Auto' selected. Below these windows is the 'Output Control' window, which is identical in both configurations. It shows 'Update rate' set to 200, 'COM Type' as '3.6V_Serial', and 'SDI12' checked. The 'Start Measurement (aM) command data acquisition period' is set to 5 seconds, highlighted with a red circle and labeled 'accusation time'.

To commit above settings to permanent memory please press set followed by save calibration

Must include:

- SDI-12 data accusation time = 10s
- SDI-12 address = 0
- Power on wipe off
- Auto range selected

10.3 Flow chart

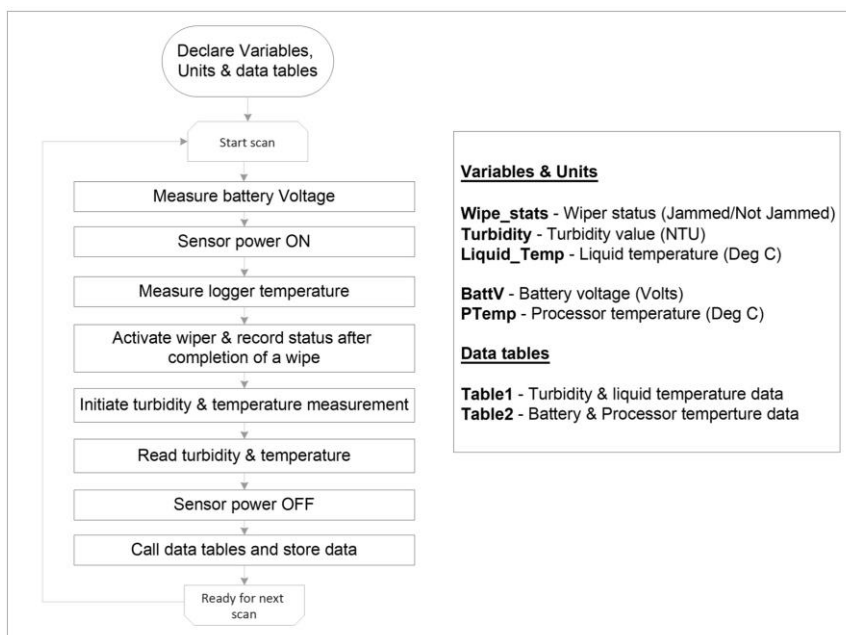

10.4 Power estimation

The following table represents the power estimation for turbidity in auto-range (ten seconds) with optical wipe and temperature measurement.

Logging time (min)	Measurement days	Measurement months	Average current (mAh)	Total sleep time per hour (sec)
1	28	0.9	14.7	2340
5	105	3.5	3.9	3348
10	163	5.4	2.55	3474
20	222	7.4	1.87	3537
30	252	8.4	1.65	3558
40	271	9.0	1.53	3568
50	283	9.4	1.47	3574
60	292	9.7	1.42	3578

Note: All of the above estimations are calculated for ideal temperatures of 25°C. Battery aging and self-discharge are not considered. When deploying for more than ten months, the estimation can vary by approximately 30%.

10.5 Example code

The following script can be adapted to perform similar operations (e.g. change scanning intervals, add data storing tables, change units, etc...).

```
'CR300 Series

'Declare Variables and Units
Public BattV
Public PTemp_C
Public SDI12_1(1)
Public SDI12_2(1)
Public SDI12_3(1)

Alias SDI12_1(1)=Wipe_stats
Alias SDI12_2(1)=Turbidity
Alias SDI12_3(1)=Liquid_Temp

Units BattV=Volts
Units PTemp_C=Deg C
Units Wipe_stats=Unit
Units Turbidity=NTU
Units Liquid_Temp=Deg C

'Define Data Tables
DataTable(Table1,True,-1)
  DataInterval(0,5,Min,10)
  Sample(1,Wipe_stats,FP2)
  Sample(1,Turbidity,FP2)
  Sample(1,Liquid_Temp,FP2)
EndTable

DataTable(Table2,True,-1)
  DataInterval(0,1440,Min,10)
  Minimum(1,BattV,FP2,False,False)
  Sample(1,BattV,FP2)
  Sample(1,PTemp_C,FP2)
EndTable

'Main Program
BeginProg
'Main Scan
Scan(5,Min,1,0)
SW12(1)
Delay(0,5,SEC)
'Default CR300 Datalogger Battery Voltage measurement 'BattV'
Battery(BattV)
'Default CR300 Datalogger Processor Temperature measurement 'PTemp_C'
PanelTemp(PTemp_C,60)
'Generic SDI-12 Sensor measurements 'Wipe_stats'
SDI12Recorder(SDI12_1(),C1,"0","M1!",1,0)
'Generic SDI-12 Sensor measurements 'Turbidity'
SDI12Recorder(SDI12_2(),C1,"0","M!",1,0,-1)
'Generic SDI-12 Sensor measurements 'Liquid_Temp'
SDI12Recorder(SDI12_3(),C1,"0","D1!",1,0,-1)

'Call Data Tables and Store Data
CallTable Table1
CallTable Table2
SW12(0)
NextScan
EndProg
```

11 Appendix C: Multiple turbidity measurements in statistical analysis with optical wiping

11.1 Script objectives

This script can be loaded onto all NEP-695 logging probes using the CR-300 PW200 application. The script turns on the sensor. After the warm up time elapses, it performs an optical wiping followed by multiple turbidity measurements and stores data at each scan (every five minutes). Then the script calls two data tables and stores the data within the datalogger:

- The script records the wiping status (if jammed or not) of the probe (Wipe_stats) and the full statistical measurements (Turbidity, Median, Average, Minimum, Maximum) in NTU within a data table (Table 1) at each scan (every five minutes).
- The script records the minimum default CR300 Battery Voltage (BattV) and the processor temperature measurement (PTemp_C) within another data table (Table 2) once a day.

The script uses the SDI-12 command “M1!” to trigger a wipe, and the command “M6!” to perform the full statistical measurements.

11.2 Wiring & NEP-5000 configuration

Please refer to **section 6.1** “Connect NEP-695 to a single NEP-5000” to properly setup and connect the logging probe to the NEP-5000 sensor.

Connect the NEP-5000 probe to your Windows computer using the Blue Box. Configure the NEP-5000 ranges using the NEP-5000 software. Apply SDI-12 settings.

Please refer to the NEP-5000 manual for more information.

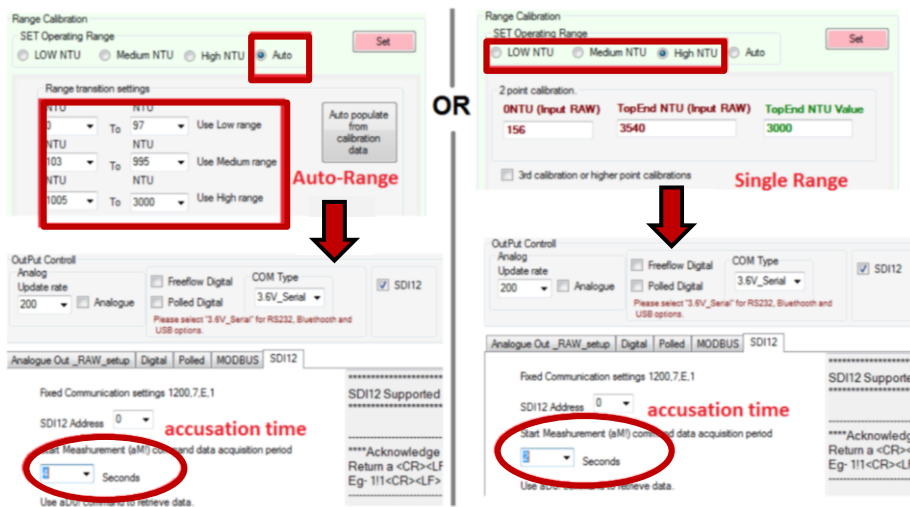

To commit above settings to permanent memory please press set followed by save calibration

Must include:

- SDI-12 data accusation time = 10s
- SDI-12 address = 0
- Power on wipe off
- Auto range selected.

11.3 Flow chart

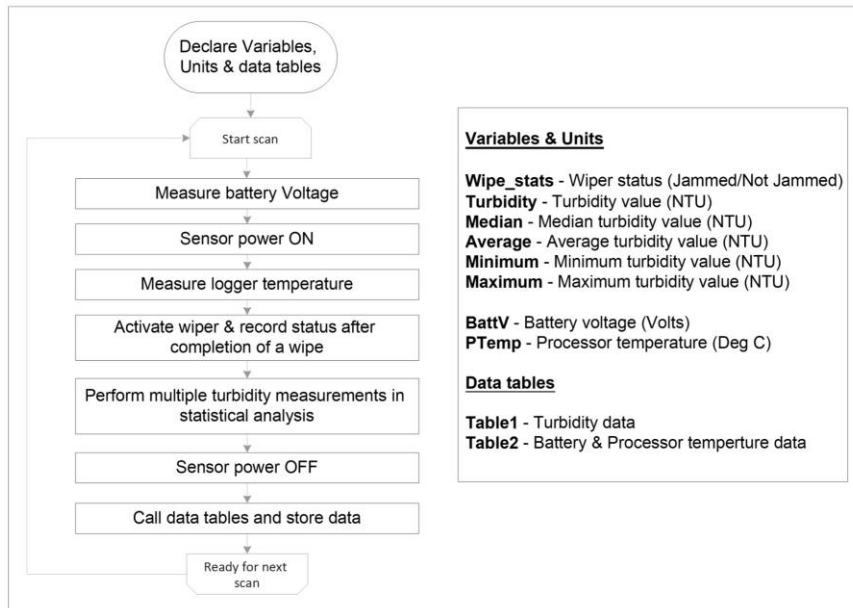

11.4 Power estimation

The following table represents the power estimation for turbidity in auto-range (fifty seconds) statistical mode (five samples) with optical wipe and temperature measurement.

Logging time (min)	Measurement days	Measurement months	Average current (mAh)	Total sleep time per hour (sec)
1	Not possible	Not possible	Not possible	Not possible
5	45	1.5	9.2	2868
10	79	2.6	5.2	3234
20	129	4.0	3.2	3417
30	164	5.4	2.5	3478
40	189	6.3	2.2	3508
50	207	6.9	2	3526
60	222	7.4	1.8	3539

Note: All of the above estimations are calculated for ideal temperatures of 25°C. Battery aging and self-discharge are not considered. When deploying for more than three months, the estimation can vary by approximately 30%.

11.5 Example code

The following script can be adapted to perform similar operations (e.g. change scanning intervals, add data storing tables, change units, etc...).

```
'CR300 Series

'Declare Variables and Units
Public BattV
Public PTemp_C
Public SDI12_1(1)
Public SDI12_2(6)

Alias SDI12_1(1)=Wipe_stats

Alias SDI12_2(1)=Turbidity
Alias SDI12_2(2)= Temperature
Alias SDI12_2(3)= Median
Alias SDI12_2(4)= Average
Alias SDI12_2(5)= Minimum
Alias SDI12_2(6)= Maximum

Units BattV=Volts
Units PTemp_C=Deg C
Units Wipe_stats=Unit
Units Turbidity=NTU
Units Temperature=Deg C
Units Median=NTU
Units Average=NTU
Units Minimum=NTU
Units Maximum=NTU

'Define Data Tables
DataTable(Table1,True,-1)
  DataInterval(0,5,Min,10)
  Sample(1,Wipe_stats,FP2)
  Sample(1,Turbidity,FP2)
  Sample(1,Temperature,FP2)
  Sample(1,Median,FP2)
  Sample(1,Average,FP2)
  Sample(1,Minimum,FP2)
  Sample(1,Maximum,FP2)
EndTable

DataTable(Table2,True,-1)
  DataInterval(0,1440,Min,10)
  Minimum(1,BattV,FP2,False,False)
  Sample(1,BattV,FP2)
  Sample(1,PTemp_C,FP2)
EndTable

'Main Program
BeginProg
'Main Scan
Scan(5,Min,1,0)
SW12(1)
Delay(0,5,SEC)
'Default CR300 Datalogger Battery Voltage measurement 'BattV'
Battery(BattV)
'Default CR300 Datalogger Processor Temperature measurement 'PTemp_C'
PanelTemp(PTemp_C,60)
'Generic SDI-12 Sensor measurements 'Wipe_stats'
SDI12Recorder(SDI12_1(),C1,"0","M1!",1,0)
'Generic SDI-12 Full measurements 'statistical'
SDI12Recorder(SDI12_2(),C1,"0","M6!",1,0,-1)

'Call Data Tables and Store Data
CallTable Table1
CallTable Table2
SW12(0)
NextScan
EndProg
```

12 Appendix D: How to configure other SDI-12 sensors

The NEP-695 is compatible with other SDI-12 sensors. Custom scripts and instructions are available to help you configure other SDI-12 sensors. Please contact Observer Instruments for further recommendations based on your sensor configuration.

© Copyright – Observator Group

Since 1924 Observator has evolved to be a trend-setting developer and supplier in a wide variety of industries. Originating from the Netherlands, Observator has grown into an internationally oriented company with a worldwide distribution network and offices in Australia, Germany, the Netherlands, Singapore and the United Kingdom.