



**Instrumentation  
Northwest, Inc.**

**Protecting our water resources since 1982**

**AquiStar<sup>®</sup>**

***TempHion*<sup>™</sup>**

**Smart Sensor**

**(pH, ISE, Redox)**

**INSTRUCTION  
MANUAL**

---

# Table of Contents

Introduction .....	3
What is the TempHion™ Smart Sensor? .....	3
Initial Inspection and Handling .....	3
Do's and Don'ts .....	3
TempHion™ Reference Electrode .....	4
Battery Life Note .....	5
General Precautions .....	5
Installation and Operation .....	6
Instrument Setup .....	6
Connecting External Power .....	6
Connecting the TempHion™ to a Computer .....	6
Installing the Aqua4Plus Software .....	7
Calibration .....	7
Field Deployment .....	7
Collecting Data .....	8
Appendix A: Care and Filling of Reference Solution Reservoir .....	11
Emptying and Cleaning the Reservoir .....	11
Filling the Reservoir .....	12
Storing Sensor .....	12
Appendix B: Field Calibration .....	13
Calibration Overview .....	13
Field Calibration Window and Calculator .....	13
Temperature Channel Calibration .....	14
pH Channel Calibration .....	14
ISE Channel Calibration .....	16
Redox Channels .....	18
Appendix C: Technical Specifications .....	20
Wiring Information .....	20
Operating Specifications .....	20
Mechanical Specifications .....	21
Power Supply .....	21
Appendix D: Changing Batteries .....	21
Appendix E: Using USB-to-Serial Cables .....	23
Reordering Information .....	23
Limited Warranty/Disclaimer - AquiStar® TempHion™ Smart Sensor .....	24

Information in this document is subject to change without notice and does not represent a commitment on the part of the manufacturer. No part of this manual may be reproduced or transmitted in any form or by any means, electronic or mechanical, including photocopying and recording, for any purpose without the express written permission of the manufacturer.

---

## Introduction

### What is the TempHion™ Smart Sensor?

The Aquistar® TempHion™ Smart Sensor is a submersible water quality sensor and datalogger capable of measuring pH, specific ions, redox, and temperature. Each unit comes with a thermistor based temperature element plus a combination of pH, ISE, or redox elements. (Contact INW for available combinations.)

The TempHion™ Smart Sensor is powered internally with two AA alkaline batteries or with an auxiliary power supply for data intensive applications. The unit is programmed using a laptop or desktop Windows® based computer via its RS485/RS232 adaptor and INW's easy-to-use Aqua4Plus software. Once programmed, the unit will measure and collect data on a variety of time intervals.

Several TempHions, or a combination of TempHions and other INW Smart Sensors, can be networked together and controlled from one location, either directly from a single computer or via a WaveData® Wireless Data Collection System.

The internal processor in the TempHion™ Smart Sensor allows for easy calibration, using the calibration utilities in Aqua4Plus. Once calibrated, this calibration data is stored in non-volatile memory within the Smart Sensor. When data is collected, this calibration information is applied to the data, resulting in highly accurate readings at a wide range of temperatures.

---

### Initial Inspection and Handling

Upon receipt of your smart sensor, inspect the shipping package for damage. After opening the carton, look for concealed damage, such as a cut cable. If damage is found, immediately file a claim with the carrier. Check the label attached to the cable at the connector end for the proper cable length.

---

### Do's and Don'ts

*Do* handle the device with care.

*Do* store in water or calibration solution and keep vertical once filled with reference solution.

*Don't* install the device so that the connector end is submerged.

*Don't* support the device with the connector or with the connectors of an extension cable. Use a strain relief device to take the tension off the connectors.

*Don't* allow the device to free-fall down a well as impact damage can occur.

*Don't* bang or drop the device on hard objects.

## TempHion™ Reference Electrode

*TempHion's patented reference electrode is the key to TempHion's superior downhole/high pressure performance.* TempHion uses a long capillary pathway, initially filled with reference electrode filling solution, to separate the reference electrode chamber from the solution being analyzed. In addition, TempHion's reference electrode is filled without *any* air (which is compressible). With this construction, the principle mechanism that will eventually allow test solution to enter the reference chamber and contaminate the reference electrode filling solution is diffusion - an exceedingly slow mechanism. Further, while the capillary pathway is narrow by garden hose standards, its open cross-section is huge compared to the microscopic openings in a conventional porous ceramic fluid/fluid junction. It is therefore much less susceptible to fouling. Fluid expansion and contraction caused by temperature variations can augment the effects of diffusion. Nevertheless, TempHion's proven stability under actual field conditions is measured in weeks or months, rather than hours or days!

Figure 1 illustrates the construction of the TempHion™ reference electrode. Please note that the capillary pathway between the reference and test solutions is established using a modified screw thread. This means that the capillary can be easily opened up for cleaning, refilling, or other maintenance.

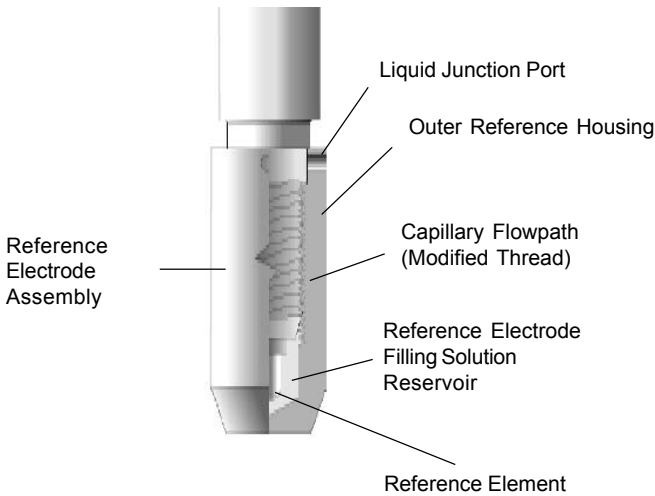

*Figure 1: Reference Electrode Assembly:  
The modified thread provides a continuous liquid path between the solution in which the instrument is immersed and the reference element.*

---

## Battery Life Note

The TempHion sensors are shipped from the factory with fresh internal AA batteries. These batteries should last several months to a year when taking samples every 15 minutes. Actual battery life may depend on battery brand, battery age, temperature of the environment, usage schedule, and other factors.

**Special note for TempHions with firmware version 0.16.** Batteries in these units have a maximum life of about 30 days, **even if the TempHion is not yet deployed.** Heavy recording schedules can decrease that life, though you should be able to get at least 20 days of life in most circumstances. Auxiliary 12-volt power supplies are available from INW with significantly longer battery life. Contact your sales representative for details.

---

## General Precautions

The rest of this manual includes step-by-step instructions for setting up the TempHion™, calibrating it, and using it in the field. When reading and following the instructions in these sections, keep these very important considerations in mind:

- Do not handle the surfaces of the sensing electrodes. Oils from fingers can “blind” the reactive surface. Rough handling can scratch the reactive surface.
- Avoid long-term exposure of silver-based sensing electrodes to bright sunlight.
- Use calibration standards that are accurately prepared. Discard standards after use. Do not return the used standards to the bottles of “fresh” solution.
- When TempHion’s reference electrode contains filling solution, TempHion must be stored in water to prevent evaporation of the filling solution.
- For any step-change in temperature (e.g., where calibration standards are at a different temperature than water to be tested) allow the instrument to come to complete thermal equilibrium before making measurements. Up to 30 minutes may be required.

---

## Installation and Operation

### Instrument Setup

The TempHion is shipped fully assembled, but without filling solution in the reference electrode. A bottle of filling solution and a plastic syringe are supplied with the instrument. TempHion is shipped with the reference electrode chemically clean and dry.

See Appendix A for care and filling of reference solution reservoir.

INW generally recommends that the instrument be stored in the lowest concentration calibration standard to be used. First, however, rinse the TempHion™ with a small portion of the calibration solution to remove excess filling solution, then place it in fresh calibration solution. Convenient containers for storage and calibration can be made from 1¼-inch PVC pipe, 14 inches in length, with a cap cemented to one end.

---

### Connecting External Power

The TempHion™ comes with two AA internal batteries. If auxiliary power is desired, you can use a 6 - 13 VDC supply that can provide 15 mA. Connect to Vaux++ (white) and Ground (blue) or contact INW for auxiliary power connectors.

---

### Connecting the TempHion™ to a Computer

The Smart Sensor cable is terminated with a weatherproof connector. Connect the weatherproof connector to your PC or laptop serial port via the interface cable and an RS485/RS232 adapter, as shown below. For USB connections, see Appendix E.

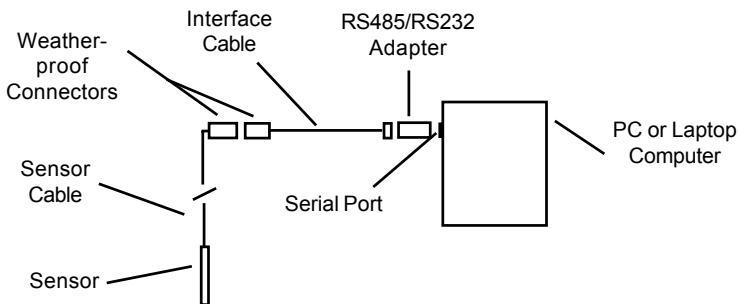

Figure 2: Connecting the Sensor to a Computer

---

## Installing the Aqua4Plus Software

The TempHion™ comes with the Aqua4Plus host software to be installed on your PC or laptop. Use this software to calibrate the sensor, to program the datalogger, to retrieve data from the logger, to view collected data, and to export data to external files for use with spreadsheets or databases. Refer to the Aqua4Plus software manual for details on installing and using Aqua4Plus.

---

## Calibration

The TempHion has two temperature channels and four millivolt channels. The millivolt channels can be configured to measure pH, redox, or various selected ions. Before leaving the factory, your sensor has been configured specifically for you. All unneeded channels have been disabled, and the active channels have been pre-configured. Disabled channels will not display in Aqua4Plus.

All active channels can be calibrated in the field. Temperature channels rarely need calibrating, however the millivolt channels should be calibrated before first use and periodically thereafter.

Environmental conditions of turbulence and temperature swings, as well as local likelihood for biofouling or mineral deposition, can vary considerably from site to site. Therefore, where the sensor is to be used for long-term monitoring, it is recommended that the calibration be initially checked frequently until a performance history is established.

See Appendix B for detailed calibration instructions.

---

## Field Deployment

Once the TempHion™ Smart Sensor has been calibrated, it should be stored vertically in water or a calibration solution until it is placed in service at the field site.

Lower the sensor to the desired depth. Fasten the cable to the well head using tie wraps or a weather proof strain-relief system. (Note that for shallow installations the liquid in which the sensor is submerged must, at all times, reach high enough to touch the metal tubing on the sensor.)

Be sure the supplied cap is securely placed on the weather-proof connector at the top of the cable. Do not install such that the connector might become submerged with changing weather conditions. The connector can withstand incidental splashing but is not designed to be submerged.



## Collecting Data

Following is a brief overview on using Aqua4Plus to collect data. Please refer to the *Aqua4Plus Instruction Manual* for further details on configuring and using Aqua4Plus.

### Real Time Monitor

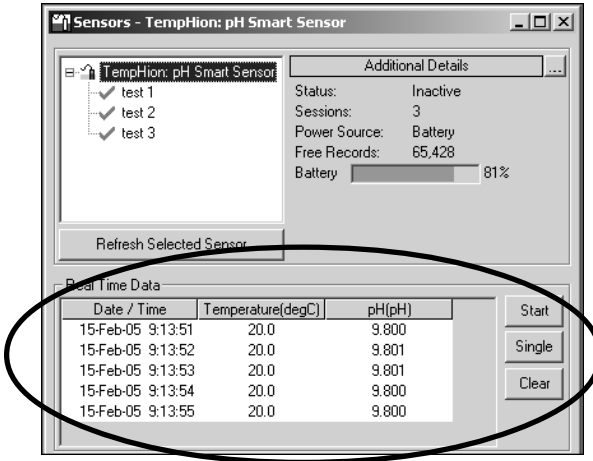

Click Single to get a single reading.

Click Start to get a reading once a second.

Click Stop to stop the reading.

Note: These are snapshot readings and are not recorded on the sensor.

Figure 3: Real Time Monitor

### Setting up a Data Recording Session

Click the  tool button. A Session Profile Window will open. Refer to the *Aqua4Plus Instruction Manual* for details in describing your session profile. Click the Start button to save the session to the sensor and begin recording.

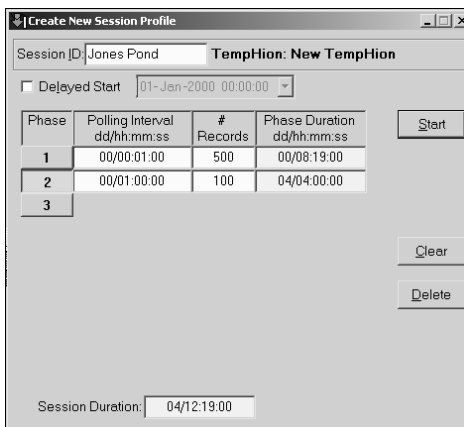



Figure 4: Session Profile Window

## Retrieving Data from the Sensor/Datalogger

- Click on the session you want to upload.
- Click the  tool button.
- Select a file location.
- Click Save.
- Click Start.

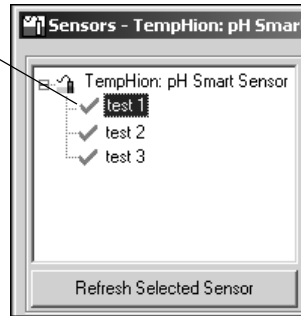



Figure 5: Session to Upload

## Viewing Data

- Click the  tool button to view data as a table.
- Click the  tool button to view data as a graph.
- Navigate to the desired file, then click the Open button. (If the File Open box does not appear, click the File Menu, then select Open.)

File Display - real pH heating up.a4d			
Sensor SN	Sensor Type	Sensor Name	Session Name
2452034	TempHion	pH Smart Sensor	Test 25A
		Temperature(degC)	pH(pH)
	Sensor Range	-40 - +125 degC	0-14 pH
	Minimum	22.0	6.986
	Maximum	28.4	7.019
	Mean	27.0	6.992
	Variance	4.02	0.0001
	Std Deviation	2.00	0.0091
	Element	30K type 5 thermistor	
	Cal Date	7-Feb-05	7-Feb-05
Rec#	Date/Time	Temperature(degC)	pH(pH)
1	07-Feb-05 13:13:03	22.0	7.018
2	07-Feb-05 13:14:03	22.0	7.018
3	07-Feb-05 13:15:03	22.0	7.019
4	07-Feb-05 13:16:03	22.2	7.016
5	07-Feb-05 13:17:03	22.7	7.013
6	07-Feb-05 13:18:03	23.3	7.005
7	07-Feb-05 13:19:03	24.0	7.002
8	07-Feb-05 13:20:03	24.6	6.998
9	07-Feb-05 13:21:03	25.2	6.996
10	07-Feb-05 13:22:03	25.7	6.993

Figure 6: File Display Window

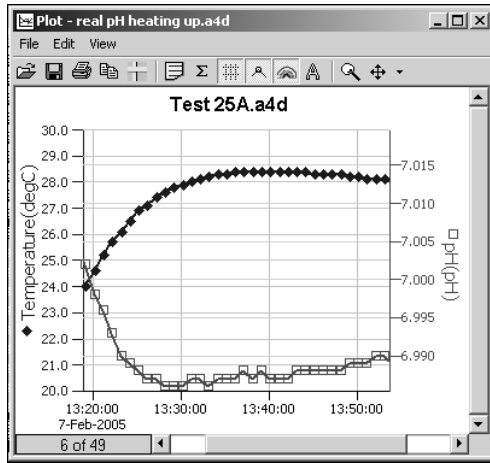



Figure 7: Graph Window

## Exporting Data to .csv or .xls Files

- Using the File Display window, open the file you want to export.
- Click on the  tool button.
- Select a file location and enter a name for the file.
- Select a file type.
- Click Save.

## A Word About Units

Readings from the TempHion™ Smart Sensor can be displayed in various units. Select the units you want from the Options | Units menu.

pH:	pH or mV
ISE:	ppm or mV
Redox:	mVH or mV
Temperature:	Degrees Celsius, Fahrenheit, or Kelvin

When using pH, ppm, or mVH units, all readings are automatically compensated for temperature and all field calibration factors are applied. When using millivolts or ohms, only the actual millivolt or resistance values are displayed - no adjustments are made.

---

## Appendix A: Care and Filling of Reference Solution Reservoir

The TempHion's patented reference electrode is key to the TempHion's superior performance. The TempHion uses a long capillary pathway, filled with reference solution, to separate the reference electrode from the solution being analyzed. Proper care and filling of this reference solution reservoir is essential to accurate functioning of the sensor.

The TempHion is normally shipped with a bottle of INW Reference Solution. If you will be using a different solution, contact INW for any adjustments that may be needed.

---

### Emptying and Cleaning the Reservoir

The TempHion is shipped fully assembled with the reservoir empty and the reference electrode chemically clean and dry. If you have just received your sensor from INW, you will not need to empty the reservoir. You should still, however, follow the instructions below for cleaning the electrode and reservoir cap.

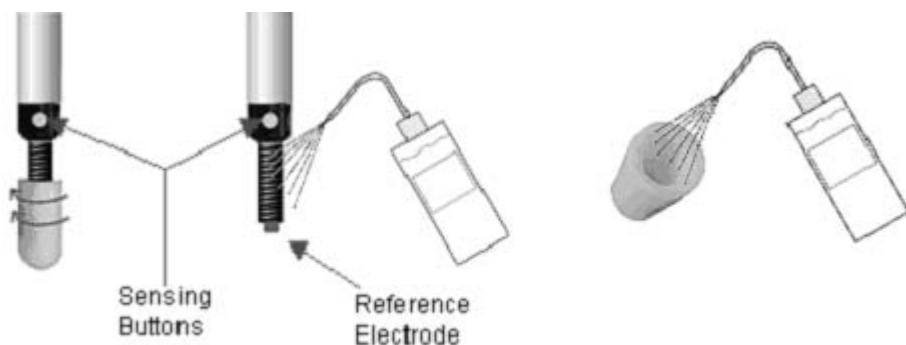

Figure 8: Rinsing the Electrode and Reservoir Cap

- Unscrew the reservoir cap. **Do not touch or scratch the sensing buttons or the reference electrode!**
- Empty any remaining filling solution from the cap.
- Thoroughly rinse the reference electrode and the inside of the cap with distilled or de-ionized water.
- There may be some crystallized residue inside the cap, on the electrode screw path, or on the electrode itself. If rinsing does not clear this away, then gently use a cotton swab or a soft toothbrush to remove the residue.
- Rinse the electrode assembly and cap thoroughly again after cleaning with the swab or brush.
- Gently, pat dry with a clean paper towel.

## Filling the Reservoir

Once the reservoir has been emptied and cleaned, you are ready to fill the reservoir with reference solution.

- Rinse the reference electrode assembly and the inside of the cap with a small amount of the reference solution.
- Empty any remaining solution from the cap.
- Fill cap about half full with reference solution.
- Holding sensor vertically, replace reservoir cap. Some solution should spill from the top as you screw the cap on. This assures that no air bubbles are trapped inside.

**If any air bubbles are trapped, a proper electrical connection cannot be made and the sensor may read erratically!**

- Once filled, keep the sensor upright in liquid to prevent the solution from drying out. A 1 to 10 ppm dilute chloride solution is recommended, but tap water will do. If you cannot keep sensor in liquid, see instructions below for storing dry.

*Figure 9: Excess filling solution spills over, forcing out any air bubbles.*

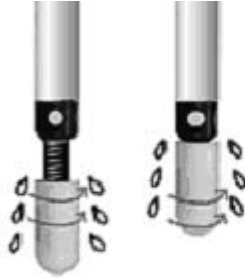

**CAUTION:** Filling solutions are not considered hazardous, but they can be irritating to the skin. Protective gloves are advised. Rinse hands or gloves with fresh water.

## Storing Sensor

For long-term storage, or when the sensor cannot be left in liquid, the sensor should be stored dry.

- Unscrew and empty the reservoir cap. **Do not touch or scratch the sensing buttons or the reference electrode!**
- Clean the cap and electrode assembly as detailed earlier in this application note.
- Let cap and electrode assembly dry thoroughly.
- Replace cap to protect electrode from scratching.

---

## Appendix B: Field Calibration

### Calibration Overview

The TempHion should be calibrated before first use and periodically thereafter. It should also be calibrated if moving to a different sampling environment where readings will be significantly different than the current environment.

Environmental conditions of turbulence and temperature swings, as well as local likelihood for bio-fouling or mineral deposition, can vary considerably from site to site. Therefore, where the sensor is to be used for long-term monitoring, it is recommended that the calibration be initially checked frequently until a performance history is established.

Aqua4Plus provides an easy-to-use calibration calculator for performing one- or two-point in-field calibrations. Two-point calibrations are more accurate and should be used whenever possible. A Calibration Kit is available from INW, which includes a beaker, pipette, measuring beaker, and stand.



- In order for the TempHion Smart Sensor to calibrate and function correctly, the filling solution reservoir must be properly filled with reference solution. For details, refer to Appendix A.
- For best results, the filling solution reservoir should be filled at least 16 hours before calibrating.
- The sensor and all calibration buffers and solutions should be at the same temperature before and during calibration.
- Calibration can only be done when there are no sessions stored on the sensor. If there are any sessions stored on the sensor, upload any data you want and then erase the sessions before continuing. (Sessions Menu | Erase All Sessions).

---

### Field Calibration Window and Calculator

Field calibration is performed on each channel separately. To calibrate a specific channel, select Field Calibration from the Configure Menu, and then click on the channel to be calibrated. Refer to Appendix B in the *TempHion Smart Sensor Instruction Manual* for general use of the field calibration window and the calculator. Follow directions below for each specific channel type.

Calculator		First Point	Second Point	Cal Values
Ref ppm	<input type="text"/>	<input type="text"/>		M: <input type="text"/>
mV	<input type="text"/>	<input type="text"/>		I: <input type="text"/>
	<input type="button" value="Measure"/>	<input type="button" value="Measure"/>		<input type="button" value="Apply"/>

Figure 10: Field Calibration Calculator

## Temperature Channel Calibration

The temperature channel rarely needs calibration. If needed, select Field Calibration from the Configure Menu. Click on Temperature, and then follow the instructions on the screen.

## pH Channel Calibration

### Preparing

- INW recommends pH buffers of 4, 7, and 10 for calibration. For a one-point calibration, select the buffer closest to the expected values in your samples. For a two-point calibration, select the two buffers that most closely bracket the expected values in your samples.
- For best results, look up the buffer's actual pH for the temperature closest to the buffer temperature during calibration. This information is available from the buffer manufacturer.

### One-Point Calibration

#### — First Calibration Point —

- Prepare the buffer.
- Rinse sensor first with distilled water and then with small amount of the buffer.
- Place sensor in buffer. (Buffer must be deep enough to cover the sensing bulb in the slot in the black module on the sensor.)
- Allow time for sensor to stabilize.
- In the **Ref pH** box for the first point, enter the reference pH as noted in the preparation section above.
- Click first **Measure** button.
- When readings have stabilized to your satisfaction, click the **OK** button in the pop-up box.

---

— **Applying Calibration Values** —

- Observe **I** value in the right hand section of the calculator. This should be between 180 and 300.
- Click the **Apply** button to apply calibration values.
- The reference value, the computed I, and the sample temperature will be transferred to the calibration fields.
- Click **OK** to save the values to the sensor.

— **Verifying Calibration Values** —

- Using the Real Time Monitor, take a few readings while the sensor is still in the buffer. Be sure units are set to pH. Readings should be very close to your selected buffer.

**Two-Point Calibration**

— **First Calibration Point** —

- Prepare first buffer.
- Rinse sensor first with distilled water and then with small amount of first buffer.
- Place sensor in buffer. (Buffer must be deep enough to cover the sensing bulb in the slot in the black module on the sensor.)
- Allow time for sensor to stabilize.
- In the **RefpH** box for the first point, enter the reference pH as noted in the preparation section above.
- Click first **Measure** button.
- When readings have stabilized to your satisfaction, click the **OK** button in the pop-up box.

— **Second Calibration Point** —

- Prepare the second buffer.
- Rinse sensor first with distilled water and then with small amount of second buffer.
- Place sensor in second buffer. (Buffer must be deep enough to contact stainless steel tube above the sensor section.)
- In the **RefpH** box for the second point, enter the reference pH as noted in the preparation section above.
- Click second **Measure** button. (Note: measured temperature must be +/- 1 degree of first measured temperature or calibration will not be accurate!)
- When readings have stabilized to your satisfaction, click the **OK** button in the pop-up box.

— **Applying Calibration Values** —

- Observe the **M** and **I** values in the right hand section of the calculator. **M** should be between -50 and -60, and **I** should be between 180 and 300.
- Click the **Apply** button to apply calibration values.
- The reference values, the computed M and I, and the sample temperature will be transferred to the calibration fields.
- Click **OK** to save the values to the sensor.



### —Verifying Calibration Values—

- Using the Real Time Monitor, take a few readings while the sensor is still in the buffer. Be sure units are set to pH. Readings should be very close to your selected buffer.

---

## ISE Channel Calibration

### Introduction to ISE Calibration

INW recommends using the “known addition method” for preparing calibration solutions. Using this method, the sensor is placed in 100 mL of distilled or de-ionized water. A small amount of standard is added to create a known concentration. The first point is measured. An additional amount of the same standard is added to create a second known concentration. The second point is measured.

INW recommends the calibration standards listed below. The following instructions are based on using one of these standards. If you use different standards or prefer not to use the known addition method, you must use some other method to determine the concentration used for the first and second point when calibrating.

### Recommended Standards

Bromide

- 0.1 Molar NaBr (equates to 7990 ppm)

Chloride

- 0.1 Molar NaCl (equates to 3550 ppm)
- 100 ppm
- 1000 ppm

### Preparing

- Select a standard that you will be using for calibration.
- Place 100 mL of distilled water in a beaker.

*Note: Temperature of the water **must remain the same** throughout the calibration. Temperature of the sensor must also be this temperature prior to calibration.*

### One-Point Calibration

#### —Computing Calibration Value—

- Rinse sensor with distilled water and pat dry.
- Place sensor in beaker of distilled water, as prepared above. (Solution must be deep enough to cover the sensing buttons.)

- Add 1 cc of selected standard to the water. Depending on which solution you are using, this will result in a concentration as shown below:
  - 0.1 Molar NaBr (Bromide) = 79.10 ppm
  - 0.1 Molar NaCl (Chloride) = 35.15 ppm
  - 100 ppm (Chloride) = 0.99 ppm
  - 1000 ppm (Chloride) = 9.90 ppm
- Stir to distribute standard evenly.
- Allow time for sensor to stabilize (15 - 20 minutes).
- In the **Ref ppm** box for the first point, enter the concentration you have chosen.
- Click the first **Measure** button. (Readings will be in mV).
- When readings have stabilized to your satisfaction, click the **OK** button on the pop-up box.

#### —Applying Calibration Values—

- Observe the **I** value in the right hand section of the calculator. For Bromide, **I** should be between 0 and 40. For Chloride, **I** should be between 120 and 160.
- Click the **Apply** button to apply calibration values.
- The reference value, the computed I, and the sample temperature will be transferred to the calibration fields.
- Click **OK** to save the values to the sensor.

#### —Verifying Calibration Values—

- Using the Real Time Monitor, take a few readings while the sensor is still in the standard. Be sure units are set to ppm. Readings should be very close to your selected concentration.

### Two-Point Calibration

#### —First Calibration Point—

- Rinse sensor with distilled water and pat dry.
- Place sensor in beaker of distilled water, as prepared above. (Solution must be deep enough to cover the sensing buttons.)
- Add 1 cc of selected standard to the water. Depending on which solution you are using, this will result in a concentration as shown below:
  - 0.1 Molar NaBr (Bromide) = 79.10 ppm
  - 0.1 Molar NaCl (Chloride) = 35.15 ppm
  - 100 ppm (Chloride) = 0.99 ppm
  - 1000 ppm (Chloride) = 9.90 ppm
- Stir to distribute standard evenly.
- Allow time for sensor to stabilize (15 - 20 minutes).
- In the **Ref ppm** box for the first point, enter the concentration you have chosen.
- Click the first **Measure** button.
- When readings have stabilized to your satisfaction, click the **OK** button on the pop-up box.

---

—**Second Calibration Point**—

- Add 10 cc of the *same* standard to the water. Depending on which solution you are using, this will result in a concentration as shown below:
  - 0.1 Molar NaBr (Bromide) = 791.8 ppm
  - 0.1 Molar NaCl (Chloride) = 351.8 ppm
  - 100 ppm (Chloride) = 9.9 ppm
  - 1000 ppm (Chloride) = 99.0 ppm
- Stir to distribute standard evenly.
- Allow time for sensor to stabilize (15 - 20 minutes).
- In the **Ref ppm** box for the second point, enter the concentration you have chosen.
- Click the second **Measure** button.
- When readings have stabilized to your satisfaction, click the **OK** button on the pop-up box.

—**Applying Calibration Values**—

- Observe the **M** and **I** values in the right hand section of the calculator. **M** should be between -50 and -60. For Bromide, **I** should be between 0 and 40. For Chloride, **I** should be between 120 and 160.
- Click the **Apply** button to apply calibration values.
- The reference values, the computed M and I, and the sample temperature will be transferred to the calibration fields.
- Click **OK** to save the values to the sensor.

—**Verifying Calibration Values**—

- Using the Real Time Monitor, take a few readings while the sensor is still in the standard. Be sure units are set to ppm. Readings should be very close to your selected concentration.

---

**Redox Channels**



- Call INW for instructions the first time you calibrate a TempHion redox channel.

Note on units: The unit “Eh” refers to readings in millivolts referenced to a hydrogen electrode. In other words, Eh represents millivolt readings that would have been obtained if using a hydrogen electrode. The units “mV” are direct millivolt readings from the sensor.

—**For Calibration You Will Need**—

- A beaker or bucket of a sample that is representative of what will be measured with the sensor.
- An alternate redox meter - such as an Orion or YSI meter.
- Distilled or deionized water.
- Paper towels.

---

**—Computing Calibration Value—**

*Note: When calibrating a redox channel, do not use the built-in calculator in the Field Calibration Window. Instead, follow the instructions below.*

1. Rinse sensor with distilled or deionized water, and then pat dry with clean paper towels.
2. Place the sensor in sample. (Solution must be deep enough to cover the sensing bulb.)
3. Using the alternate meter, take a redox measurement of that sample. Use either plain mV or Eh, whichever you normally use.
4. In Aqua4Plus - set display units to either mV or Eh, whichever you used for the above step.
5. Scan for and click on the sensor.
6. Open the field calibration window (*Configure | Field Calibration*).
7. Click on the redox channel, and then enter a zero in the offset box.
8. Click **OK**
9. Take two or three single readings using the Real Time monitor and note the redox value.
10. Subtract this value from the value read in the step 3.

**—Applying Calibration Value—**

11. Open the field calibration window.
12. Click on the redox channel, and then enter this value in the offset box.
13. Click **OK**.

**—Verifying Calibration Values—**

14. Take another couple single Real Time readings. These should be close to the reading taken with the other meter.

---

## Appendix C: Technical Specifications

---

### Wiring Information

Cable Type: 9-conductor, shielded

Shield	=	Ground
White	=	Vaux (6 to 13 VDC)
Brown	=	Digital out
Orange	=	Vbat+ (1.8 to 3.3 VDC)
Blue	=	Ground
Yellow	=	CommD+
Purple	=	CommD-

---

### Operating Specifications

#### pH

Accuracy (typical)	$\pm 0.2$ pH units
Resolution	0.001 pH units

#### ISE

Accuracy (typical)	$\pm 5\%$ of reading
Resolution	0.1 ppm

#### Redox

Accuracy (typical)	$\pm 5\%$ of reading
Resolution	0.1 mVH

#### Temperature

Accuracy	$\pm 0.5^\circ\text{C}$
Resolution	0.1 $^\circ\text{C}$

#### Time

Accuracy	$\pm 6$ sec/day	$\pm 2$ sec/day (typical)
----------	-----------------	---------------------------

#### Recommended Operating

##### Temperature Range

0 $^\circ\text{C}$  to 40 $^\circ\text{C}$   
 Contact factory for extended temperature ranges.

---

## Mechanical Specifications

### Sensor

Length:	13.25" to 17.25" depending on configuration
O.D.	0.75"
Body Material	Delrin® and 316 stainless steel
Seal Materials	Viton® and Teflon®
Reference Electrode	Patented capillary liquid junction with Ag/AgCl electrode
Reference Electrolytes	TempHion - no heavy metals and non-contaminating
Thermistor	30K Ohm
pH Electrode	General purpose glass
Chloride Electrode	Solid state
Bromide Electrode	Solid state
Nitrate Electrode	Membrane
Redox	Platinum Ring

### Cable

OD	0.28" maximum
Break Strength	138 lbs.
Weight	4 lbs. per 100 feet

---

## Power Supply

Internal	2 AA Alkaline Batteries
Auxiliary	6-13 VDC, 15 mA

---

## Appendix D: Changing Batteries

Because changing the batteries involves opening the water-tight seal, **this must be done in a clean, dry environment to avoid contamination or moisture damage to the circuitry.**

**Battery Type:** Two standard AA Alkaline batteries.

**Replacing the Batteries:** Open the housing by removing the top-cap, as outlined below. The top-cap is the connector between the tube housing, the sensor and the cable.

1. Twisting gently, unscrew the top-cap.
2. Gently separate the top-cap from the body of the sensor. Top-cap remains attached to body via several colored wires.

**Caution!** Pulling forcefully on the top-cap can pull the insides out of the sensor or snap the connections inside. Removing the circuit board or pushing on the surface of the pressure element **may void your warranty.**

**Note:** O-rings provide a water-tight seal for the sensor housing. Take care not to nick or otherwise damage these O-rings.

3. Tip housing over and gently slide batteries out.
4. Insert new batteries - **positive terminals towards the top-cap**.
5. Replace and retighten top-cap.



*Figure 11a: Remove top-cap*

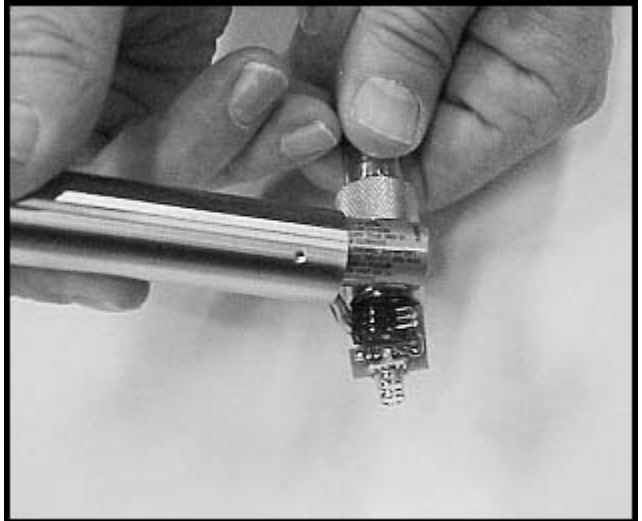

*Figure 11b: Slide batteries out*

## Appendix E: Using USB-to-Serial Cables

The standard communication cable/RS485-232 adapter that comes with the Smart Sensor plugs into a 9-pin serial port on the PC or laptop. Many new computers, especially laptops, do not have 9-pin serial ports. If you have one of these computers, or if all of your serial ports are in use, you can connect to a Smart Sensor using a USB to Serial adapter, as shown in figure 12.

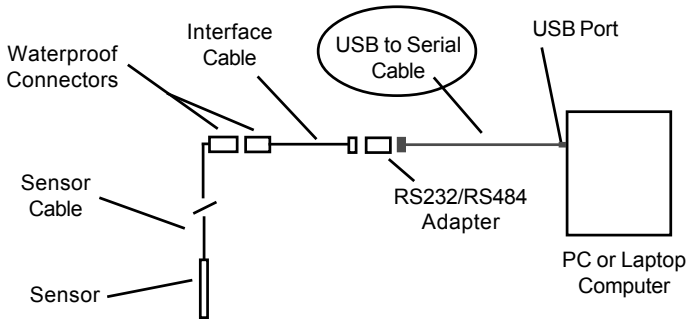

Figure 12: Connection using a USB to Serial Cable

USB-to-Serial cables are readily available from many electronics and computer stores, as well as numerous sites on the Internet. INW has tested and recommends the Keyspan USA-19HS. It is available from INW or on the Internet. Install as follows:

- Plug into USB port
- Install the drivers provided with the particular unit
- Note new COM port number. (Right click on My computer. Select Manage. On left panel click on Device Manager. On right panel double-click on Ports. The new COM port should be listed.)
- Connect to the smart sensor (See Figure 12 above.)
- On the Aqua4Plus software, select the COM port noted above.

---

## Reordering Information

For sales & service offices, please contact:

**Instrumentation Northwest, Inc.**

www.inwusa.com

**800-776-9355**



---

**LIMITED WARRANTY/DISCLAIMER -  
AquiStar® TempHion™ Smart Sensor**

**A. Seller warrants that products manufactured by Seller when properly installed, used and maintained, shall be free from defects in material and workmanship. Seller's obligation under this warranty shall be limited to replacing or repairing the part or parts or, at Seller's option, the products which prove defective in material or workmanship within ONE (1) year from the date of delivery, provided that Buyer gives Seller prompt notice of any defect or failure and satisfactory proof thereof. Any defective part or parts must be returned to Seller's factory or to an authorized service center for inspection. Buyer will prepay all freight charges to return any products to Seller's factory, or any other repair facility designated by Seller. Seller will deliver replacements for defective products to Buyer (ground freight prepaid) to the destination provided in the original order. Products returned to Seller for which Seller provides replacement under this warranty shall become the property of Seller.**

This limited warranty does not apply to lack of performance caused by abrasive materials, corrosion due to aggressive fluids, mishandling or misapplication. Seller's obligations under this warranty shall not apply to any product which (a) is normally consumed in operation, or (b) has a normal life inherently shorter than the warranty period stated herein.

In the event that equipment is altered or repaired by the Buyer without prior written approval by the Seller, all warranties are void. Equipment and accessories not manufactured by the Seller are warranted only to the extent of and by the original manufacturer's warranty.

THE FOREGOING WARRANTIES ARE IN LIEU OF ALL OTHER WARRANTIES, WHETHER ORAL, WRITTEN, EXPRESSED, IMPLIED OR STATUTORY. IMPLIED WARRANTIES OF FITNESS AND MERCHANTABILITY SHALL NOT APPLY. SELLER'S WARRANTY OBLIGATIONS AND BUYER'S REMEDIES THEREUNDER (EXCEPT AS TO TITLE) ARE SOLELY AND EXCLUSIVELY AS STATED HEREIN. IN NO CASE WILL SELLER BE LIABLE FOR CONSEQUENTIAL DAMAGES, LABOR PERFORMED IN CONNECTION WITH REMOVAL AND REPLACEMENT OF THE SENSOR SYSTEM, LOSS OF PRODUCTION OR ANY OTHER LOSS INCURRED BECAUSE OF INTERRUPTION OF SERVICE. A NEW WARRANTY PERIOD SHALL NOT BE ESTABLISHED FOR REPAIRED OR REPLACED MATERIAL, PRODUCTS OR SUPPLIES. SUCH ITEMS SHALL REMAIN UNDER WARRANTY ONLY FOR THE REMAINDER OF THE WARRANTY PERIOD ON THE ORIGINAL MATERIALS, PRODUCTS OR SUPPLIES.

B. With respect to products purchased by consumers in the United States for personal use, the implied warranties including but not limited to the warranties of merchantability and fitness for a particular purpose, are limited to twelve (12) months from the date of delivery.

Some states do not allow limitations on the duration of an implied warranty, so the above limitation may not apply to you. Similarly, some states do not allow the exclusion or limitation of consequential damages, so the above limitation or exclusion may not apply to you. This limited warranty gives you specific legal rights; however, you may also have other rights which may vary from state to state.

 [www.inwusa.com](http://www.inwusa.com)

Please visit INW's Web site to learn more about our products and services.

Copyright© 1997 - 2009 by Instrumentation Northwest, Inc. All rights reserved.  
Instrumentation Northwest and INW are trademarks registered with the  
U.S. Patent & Trademark Office.

Printed on recycled paper.

Doc#9B0810r4 8/09



## **Instrumentation Northwest, Inc.**

**8902 122nd Avenue NE**

**Kirkland, WA 98033**

**(425) 822-4434 • (425) 822-8384 (fax)**

**(800) 776-9355 • [www.inwusa.com](http://www.inwusa.com)**