



Wynn Marine Ltd

2-4 Merse Road, North Moons Moat, Redditch, Worcestershire B98 9HL

Tel: +44 (0) 1527 61243, Fax: +44 (0) 1527 66836

Email: [sales@wynn.co.uk](mailto:sales@wynn.co.uk), website [www.wynn.co.uk](http://www.wynn.co.uk)

## **Installation Manual**

**for**

## **1000 Control System**

**WARNING:** A suitably qualified person should perform all installation and maintenance. All electrical wiring should be carried out in accordance with relevant regulations. Ensure all products are correctly earthed and all connections are made in accordance with the wiring diagram. Non-compliance may result in damage, malfunction or personal injury. Before commencing any installation or maintenance work, ensure that the electrical supply is disconnected.

## Series 1000 Control Unit

Series 1000 controllers are available in units from 1 – 4 ways. They allow direct connection to the wiper motor without the need for intermediate power supplies. Wipers are controlled in continuous or variable intermittent modes. Switches are fitted for Spray and Heater control. A park sensor allows the wiper to park at the motor end when it reaches the end of stroke.

The system complies with all relevant safety and EMC regulations.

## Installation of Controller



Installation of the control unit and wiper must be done by a competent electrician.

1. Cut out and de-burr a hole in the console, relevant to the sizes shown in the table below.

Controller Type	Panel cut out (mm)	Overall size (mm)
1-way	45 x 91	48 x 96
2-way	91 x 91	96 x 96
3-way	139 x 91	144 x 96
4-way	186 x 91	192 x 96

2. Remove the 2 fixing brackets from the side of the controller case, noting how these fit.
3. Fit the unit into the mounting hole and secure with the fixing brackets.
4. Connect the wiring as shown in the wiring diagram.

## Functional Check of Controller

The wiper switch has 6 positions. Fully anti-clockwise parks the wiper, next are four settings are for Intermittent wipe and finally continuous speed operation when turned fully clockwise.

1. Set wiper switch to the off position (fully anti-clockwise) & apply power to the system. Check each wiper switch in turn as follows.
2. Turn wiper switch fully clockwise. The wiper should start and run continuously.
3. Turn the wiper switch fully anticlockwise. The wiper should park at the motor end of its stroke.
4. Turn the wiper switch clockwise one position. The wiper will make one wipe and park again. This position gives the longest intermittent time (20 seconds).
5. Turn the wiper switch clockwise one position at a time. Each time the switch is turned the wiper should wipe once and park again. At the last position, just before fully clockwise, the intermittent interval should be around 4 seconds.
6. Heater. Switch on and ensure that the wipers begin to heat up.
7. Wash. Switch on and hold down, ensure water is sprayed through the system.
8. Multi-way grouped controllers with only one control switch has all the wipers operating together.

## Fusing



Remove power prior to working on controller.

The controller has fuses to protect the motor, wiring and controller. The fuses will not blow in normal use, however, if the wiper is jammed, then these fuses are designed to blow before the motor will sustain any damage. The fuses are located behind the front panel inside the control unit. To replace a fuse:

1. Use a small screwdriver to carefully lever off the front panel bezel.
2. Holding the control knob, carefully pull out the controller front panel.
3. Undo the fuse holder which is located at the bottom right of the relevant controller PCB.
4. Renew the fuse and carefully refit the fuse holder. Avoid excessive force. Refit front panel and bezel.

# Single Way Dimensions

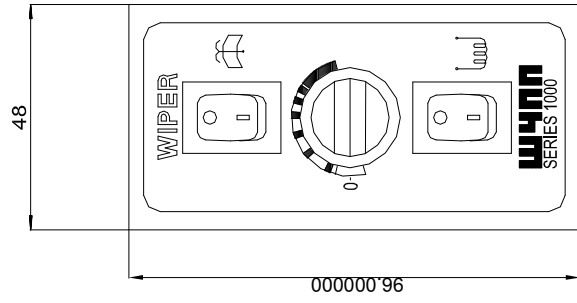

1000-VVV-110  
STANDARD

CONTROLLER OPTION			SWITCH FITTED AS DRAWN	BLANKING PLUG FITTED
1000-VVV-110	✓	✓	✓	✓
1000-VVV-111	X	X	X	X
1000-VVV-112	✓	X	X	X
1000-VVV-113	X	X	X	X

WEIGHT OF UNIT - 0.4 KG

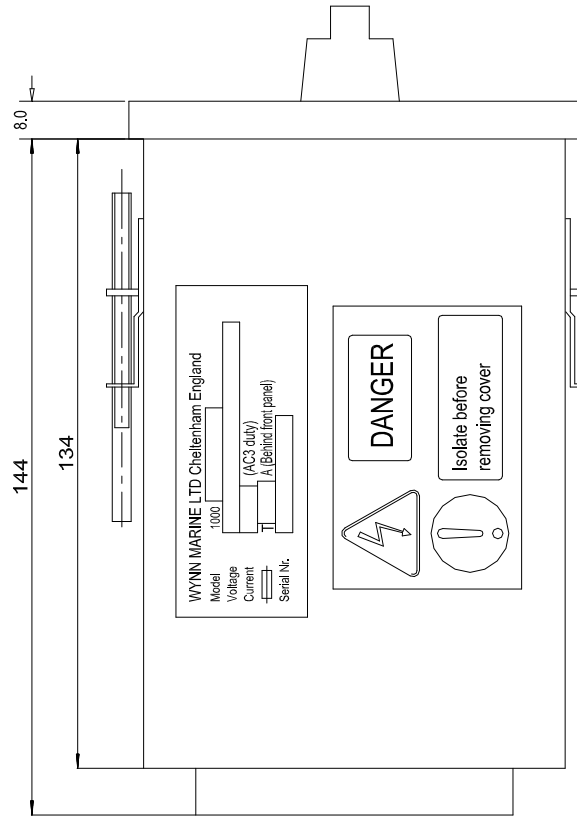

VVV	VOLTAGE OPTION	ELECTRICAL DIAGRAM
012	12V DC	1000-002-DC
024	24V DC	1000-002-DC
100	100V AC	1000-002-AC
115	115V AC	1000-002-AC
230	230V AC	1000-002-AC

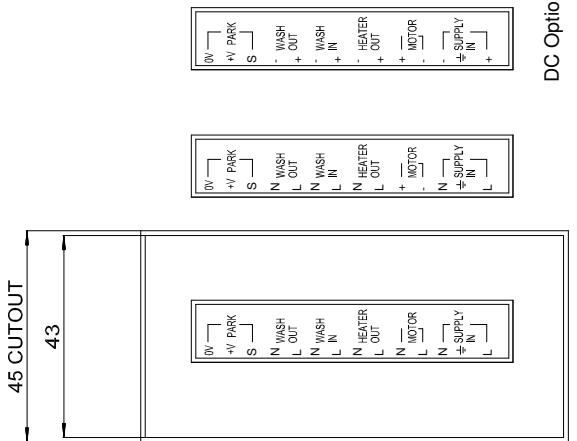

AC Option

ACin/DC out Option

DC Option

Date:- 03.09.01  
Path:- Draw\1000Manual\110-i6

# Series 1000 Front Panel Layouts

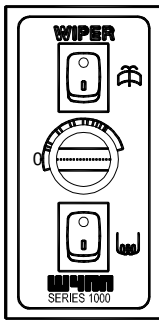

1 WAY



2 WAY GROUPED

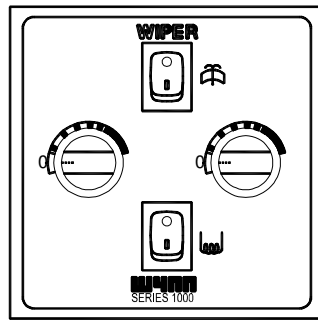

2 WAY INDEPENDENT

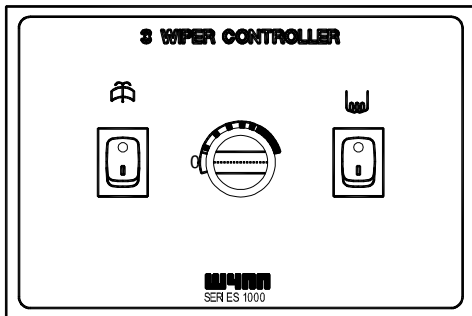

3 WAY GROUPED

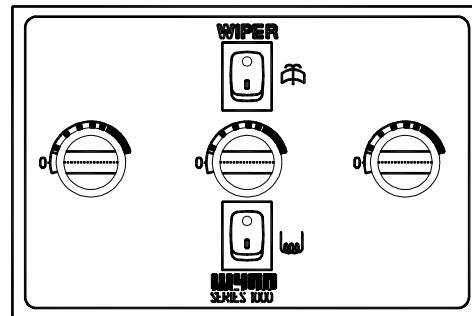

3 WAY INDEPENDENT

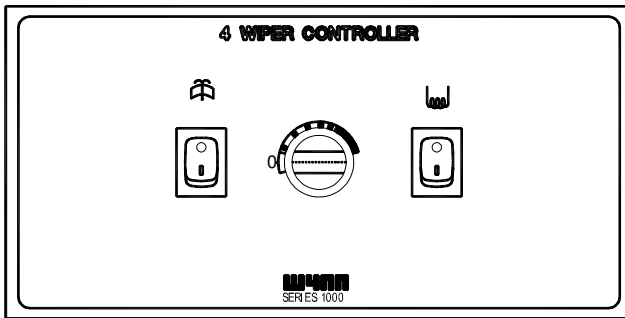

4 WAY GROUPED



WASHER SWITCH



WIPER OPERATION  
MODE SWITCH



HEATER SWITCH

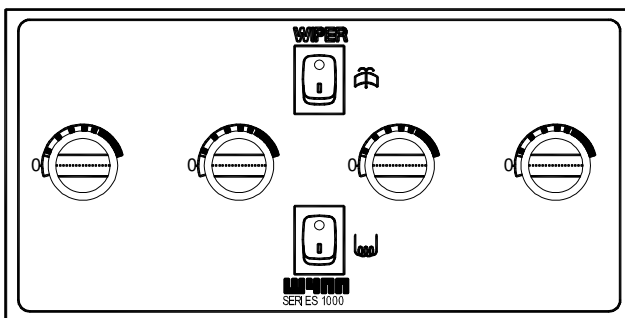

4 WAY INDEPENDENT

110001Manual1000 frontpanelspoty

# 1-Phase AC Motor with Series 1000 Controller

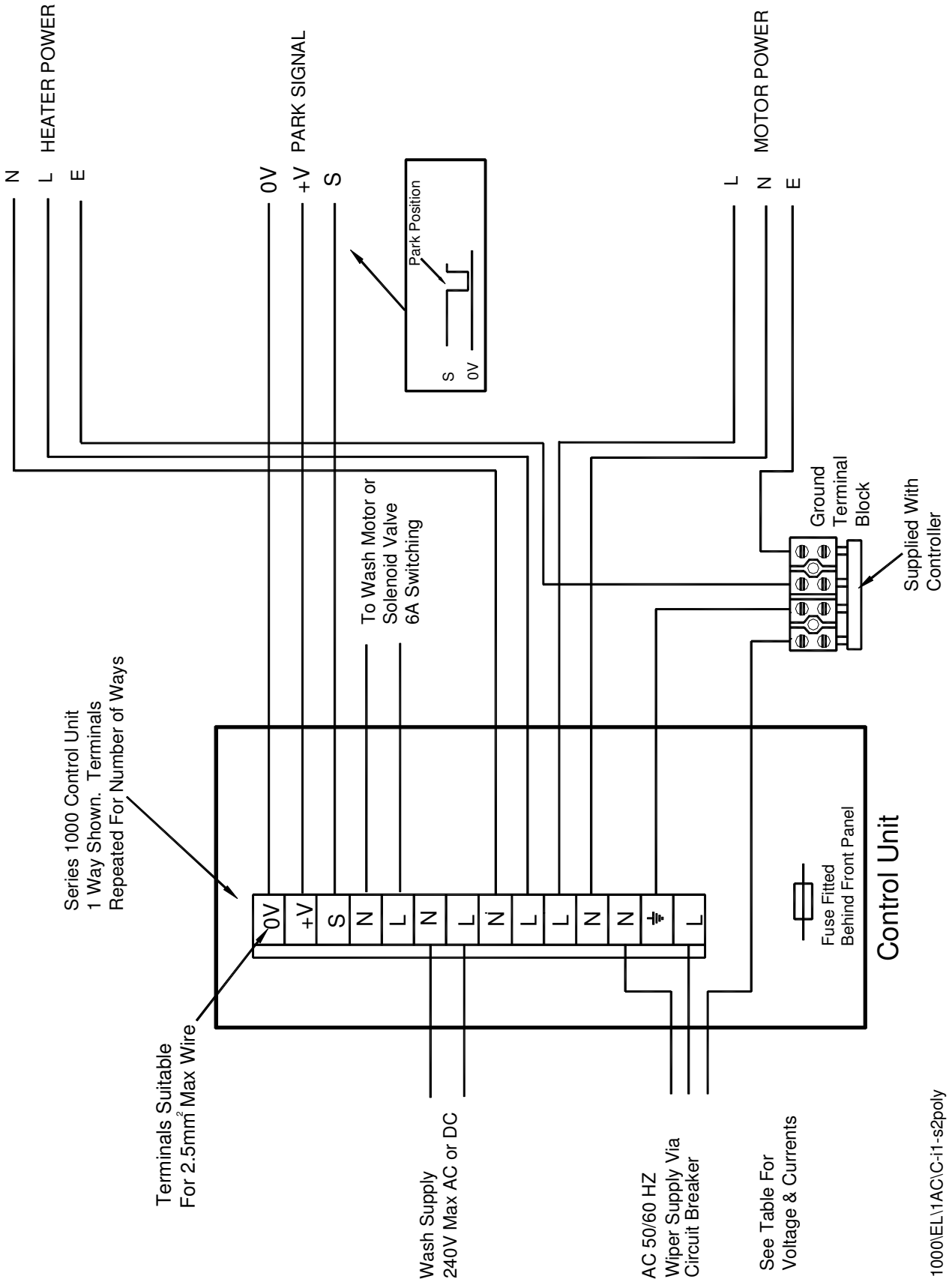

1000\EL\1AC\C-I1-s2poly

## **Documentation**

Whilst every effort is made to provide accurate information in good faith, no responsibility can be accepted by Wynn for inaccuracies and Wynn reserves the right to alter and amend specifications and designs without prior notice in line with our policy of continued improvement.

## **Spares Parts**

To enable technical troubleshooting and ordering of spare parts, this manual should be kept in a safe place on board. It is also advisable to keep one set of spare parts on board for emergency use. Please contact Wynn directly or your local distributor / service centre for all order requirements.

## **Maintenance Schedules**

Plan your maintenance work according to the schedule in this manual.

## **Our Commitment**

We are committed to a 10 year product support programme. This ensures that any spare part will be available for any wiper at least 10 years after its purchase. It is strongly recommended that only genuine replacement parts manufactured by WYNN be used. This will guarantee that only suitable materials have been used and will ensure interchangeability of parts.

## **Quality and Testing**

We are committed to the principles of Total Quality Management, ISO 9000. We manufacture our range of marine products to the highest standard and quality. We therefore maintain an ongoing schedule of product improvement and testing. To help us sustain such standards we maintain a salt-water test rig on which our products are taken, at random from the production line, and subjected to 3,000 hour continuous testing. We are sure you will receive many years trouble-free service from your Wynn product and hope you find this information pack comprehensive.

## **Guarantee**

All Wynn equipment is tested before despatch from our works. Should any product or part prove defective in material or workmanship within one year of entering service, or two years of leaving the factory, whichever is the shortest, it will be repaired or replaced free of charge. No further claim can be considered.

We cannot accept any responsibility for the installation of equipment, or damage to the equipment during installation, or normal wear and tear. The guarantee is negated if the equipment is not installed strictly observing the instructions set out in this manual, or not maintained as specified.

This guarantee is expressly in lieu of all other guarantees expressed or implied and of all other obligations of liabilities on our part, and we neither assume nor authorise any other person to assume for us any other liability in connection with the sale of our equipment. Faulty equipment must be returned, carriage paid, to our works for examination. Any legal action must be settled in the English courts under English law.



A worldwide network of agents supports Wynn's Marine product range. For details of the nearest Wynn agent please contact our Head Office. Wynn Agents operate in the following countries.

Argentina, Australia, Brazil, Canada, Chile, China, Croatia, Denmark, Egypt, Finland, France, Germany, Greece, Hong Kong, Iceland, India, Israel, Italy, Japan, Korea, Netherlands, New Zealand, Norway, Oman, Peru, Poland, Portugal, Russia, Singapore, South Africa, Spain, Sweden, Taiwan, Turkey, Ukraine, U.S.A.



Wynn Marine Ltd

2-4 Merse Road, North Moons Moat, Redditch, Worcestershire B98 9HL

Tel: +44 (0) 1527 61243, Fax: +44 (0) 1527 66836

Email: [sales@wynn.co.uk](mailto:sales@wynn.co.uk), website [www.wynn.co.uk](http://www.wynn.co.uk)